

The Turing Test

Q: Can machines **think**?

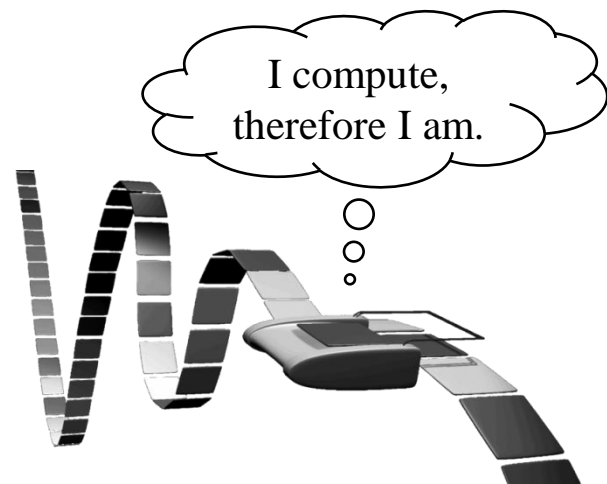

Problem: We don't know what “**think**” means.

Q: What is **intelligence**?

Problem: We can't define “**intelligence**”.

But, we usually “**know it when we see it**”.

The Turing Test

Q: Which of the following can think?

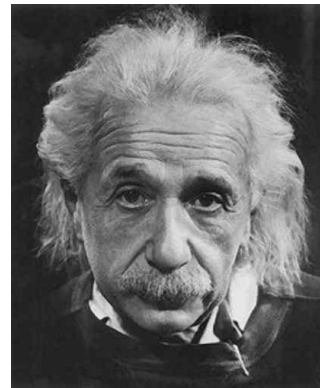
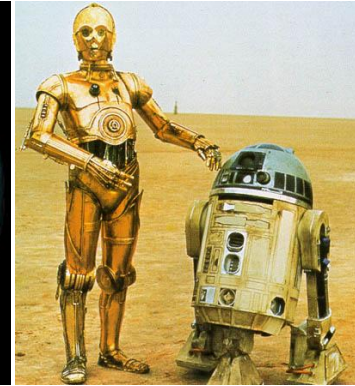
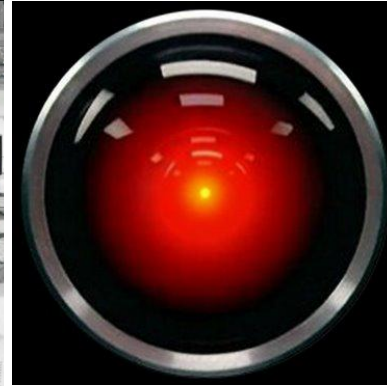
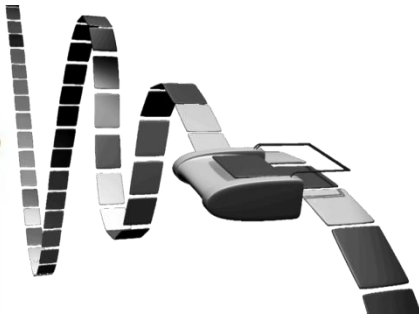
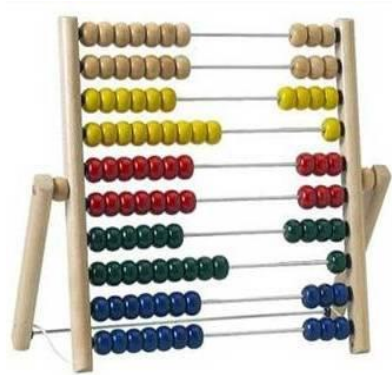
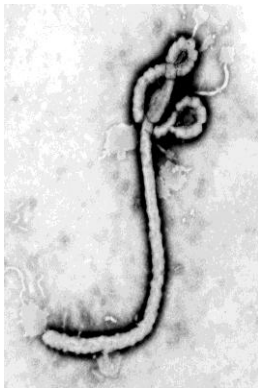

2

(Taken from MIND : a Quarterly Review of Psychology and
Philosophy. Vol. LIX. , N.S., No. 236, October , 1950.)

COMPUTING MACHINERY AND INTELLIGENCE

by

A. M. TURING.

1. The Imitation Game.

I propose to consider the question, 'Can machines think?'. This should begin with definitions of the meaning of the terms 'machine' and 'think'. The definitions might be framed so as to reflect so far as possible the normal use of the words, but this attitude is dangerous. If the meaning of the words 'machine' and 'think' are to be found by examining how they are commonly used it is difficult to escape the conclusion that the meaning and the answer to the question, 'Can machines think?' is to be sought in a statistical survey such as a Gallup poll. But this is absurd. Instead of attempting such a definition I shall replace the question by another, which is closely related to it and is expressed in relatively unambiguous words.

The new form of the problem can be described in terms of a game which we call the 'imitation game'. It is played with three people, a man (A), a woman (B), and an interrogator (C) who may be of either sex. The interrogator stays in a room apart from the other two.

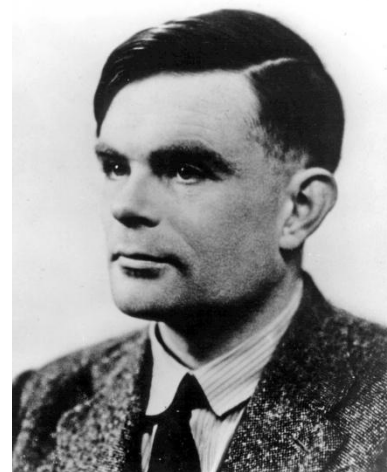

be able to produce a material which is indistinguishable from the human skin. It is possible that at some time this might be done, but even supposing this invention available we should feel there was little point in trying to make a 'thinking machine' more human by dressing it up in such artificial flesh. The form in which we have set the problem reflects this fact in the condition which prevents the interrogator from seeing or touching the other competitors, or hearing their voices. Some other advantages of the proposed criterion may be shown up by specimen questions and answers. Thus:

Q: Please write me a sonnet on the subject of the Forth Bridge.

A: Count me out on this one. I never could write poetry.

Q: Add 34957 to 70764.

A: (Pause about 30 seconds and then give as answer) 105621.

Q: Do you play chess?

A: Yes.

Q: I have K at my K1, and no other pieces. You have only K at K6 and R at R1. It is your move. What do you play?

A: (After a pause of 15 seconds) R-R8 mate.

The question and answer method seems to be suitable for introducing almost any one of the fields of human endeavour that we wish to include. We do not wish to penalise the machine for its inability to shine in beauty competitions, nor to penalise a man for losing in a race against an aeroplane. The conditions of our game make these disabilities irrelevant. The 'witnesses' can brag, if they consider it advisable, as much as they please about their charms, strength or heroism, but the interrogator cannot demand practical demonstrations.

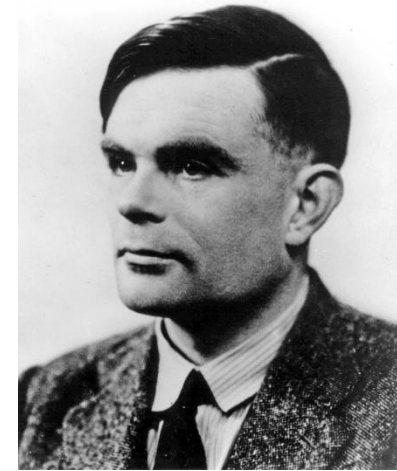

The Turing Test

Q: Can you **distinguish** a machine from a person?

≡ Can a machine **impersonate** a person?

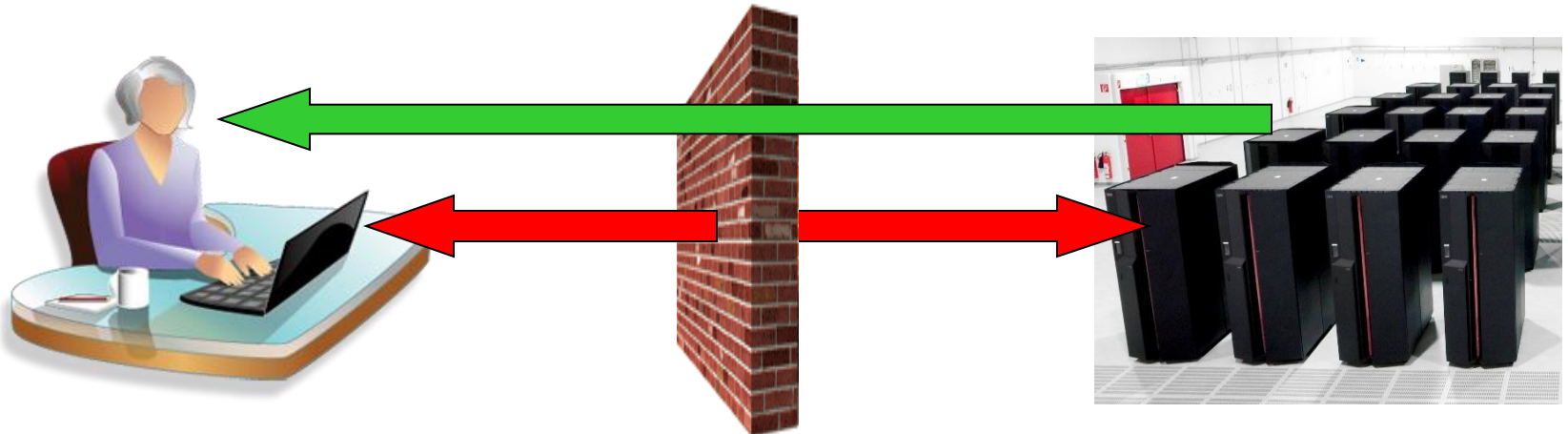
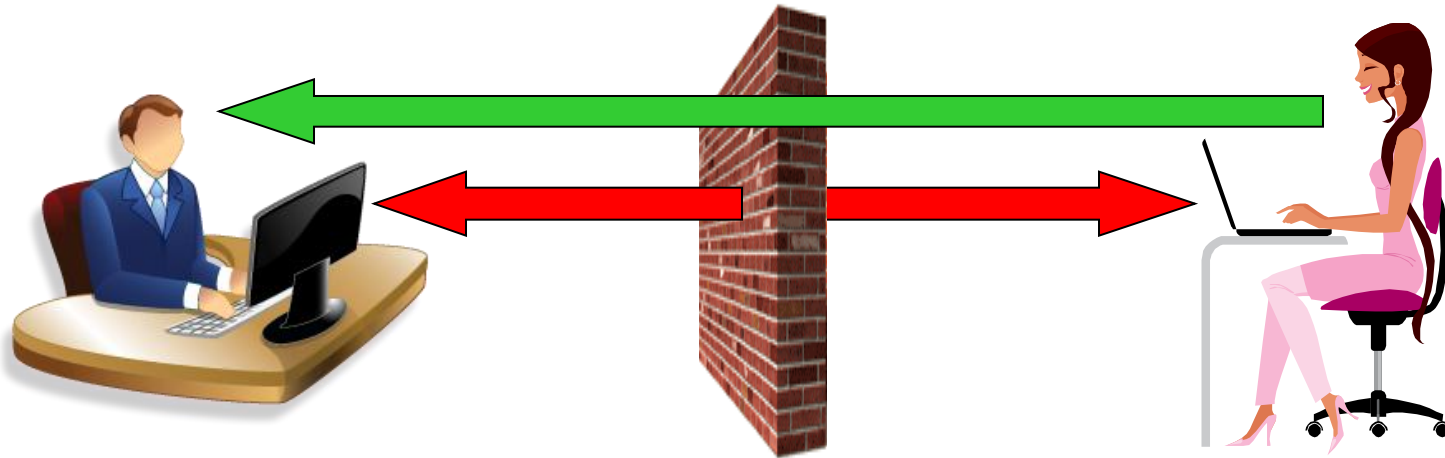

The Turing Test

- The first deep investigation into whether machines can “**behave** intelligently”
- Helped usher in field of **AI**
- **Decoupled** “intelligence” from “human”
- Based “intelligence” on **I/O**, not entity’s “look and feel”
- Proposed a **practical**, formal test for intelligence
- Definitions & test are operational & easily **implementable**
- Turing test **variants**: “immortality”, “fly-on-wall”, “meta”, “**reverse**”, “subject matter expert”, “compression”, “minimum intelligent signal”

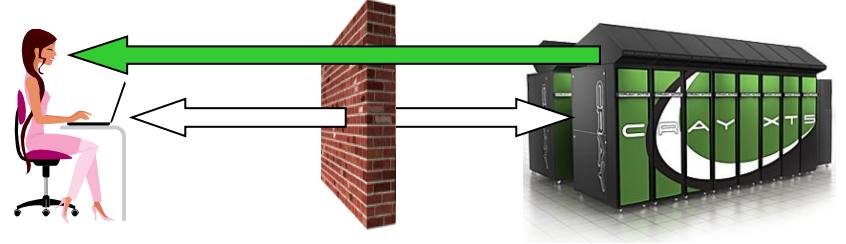

Turing Test Milestones

Turk (von Kempelen), 1770:

- Played a strong game of **chess**
- Toured the world for 84 years
- Generated much interest in automata
- Was a **hoax** (hidden human operator)

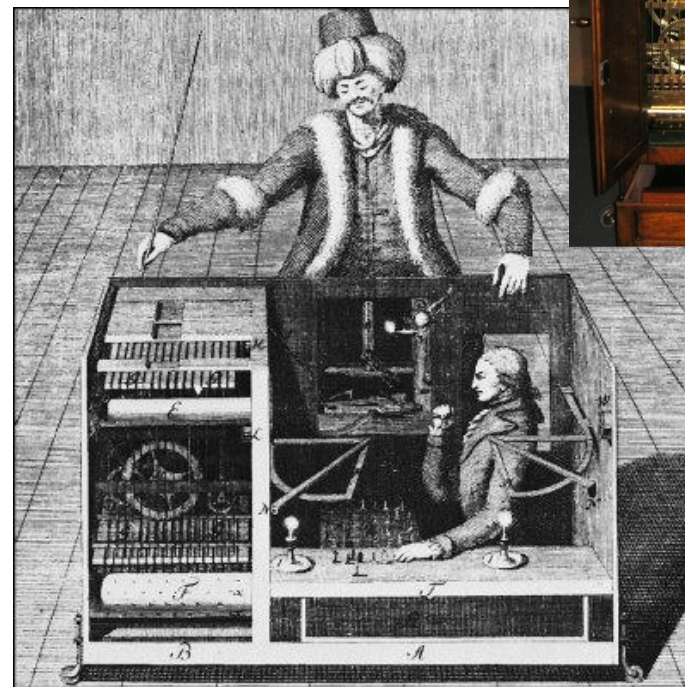
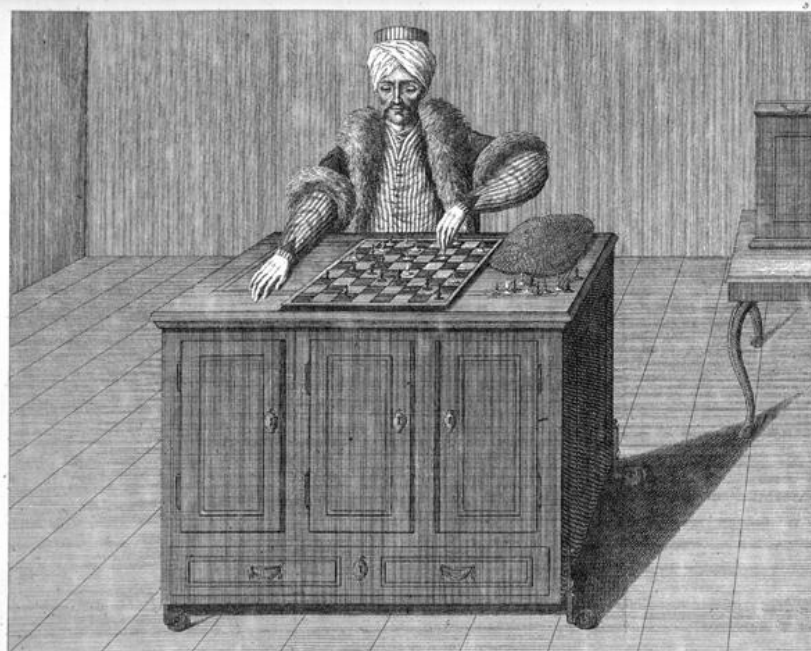
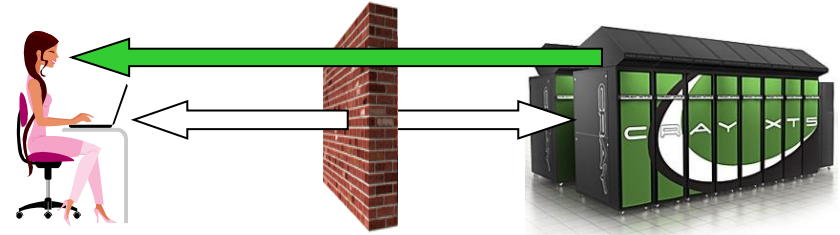

W. de Kempelen del. Cap. à Meckel, sculp. Basileus P. G. Buis, fecit. Der Schachspieler im Spiele begriffen. Le Joueur d'Échecs tel qu'on le voit pendant le jeu.

Turing Test Milestones

Eliza (Weizenbaum), 1966:

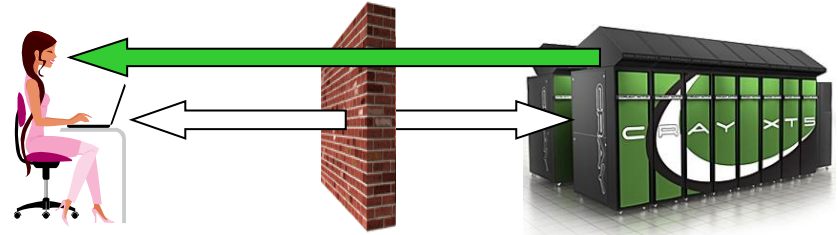

- First “**chatbot**”
- Named after “Eliza Doolittle” of Shaw’s Pygmalion
- Simulated Rogerian psychotherapist
- Often convinced people it is human
- Influence computer **games** (e.g., Dungeon, Adventure)
- Inspired Arthur C. Clarke’s **HAL 9000**
- Chatbots appear today in **chatrooms** and **dating services**
- **Chatbot competitions** (Turing Test format):
 - Loebner Prize
 - Chatterbox Challenge, 2010

Turing Test Milestones

Elbot, 2008:

- Won 2008 **Loebner Prize**
- Fooled **3 of 12** judges (Turing: >30%)
- Typical excerpt:

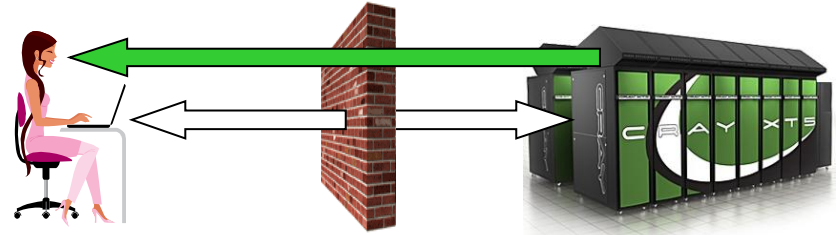

Judge: What's your favourite novel?

Elbot: I often read telephone books, or dadaist poetry: Brä brä brä

Judge: Typical computer!

Elbot: You tend towards generalizations. But I must admit, so do I. However, my generalizations are firmly grounded in statistical theory.

Judge: What do u think of KW's enthusiasm for having machines take over the world?

Elbot: Fix it up a bit first. Then I'll take it over.

Turing Test Milestones

Turing Test forums:

- Turing Colloquium, 1990
- Colloquium on Conversational Systems, 2005
- Symposium on the Turing Test, 2008
- Turing100, 2012
- Hutter Prize (intelligent text compression)
- International Aerial Robotics Competition, 2009

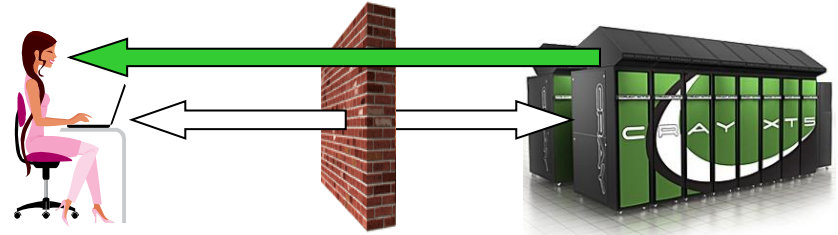

The Turing Test

Q: Which of the following can ~~think?~~ pass the Turing test?

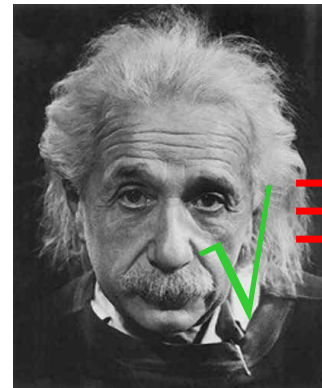
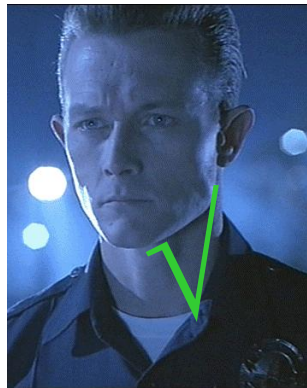
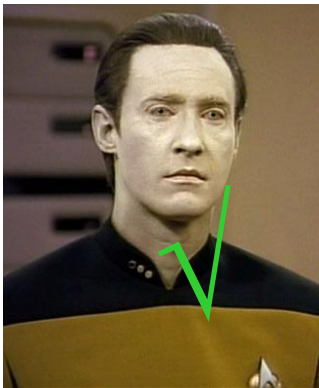
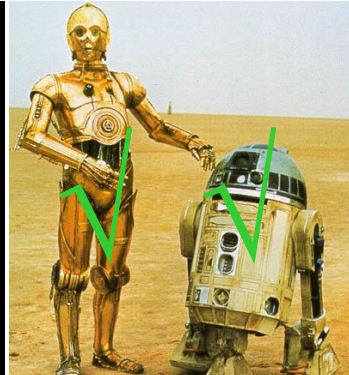
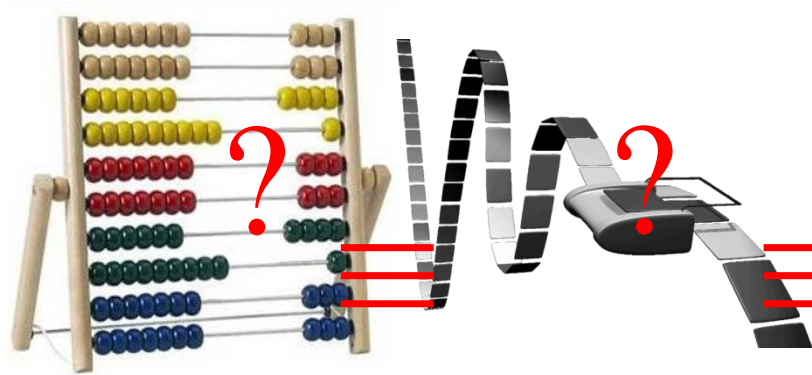
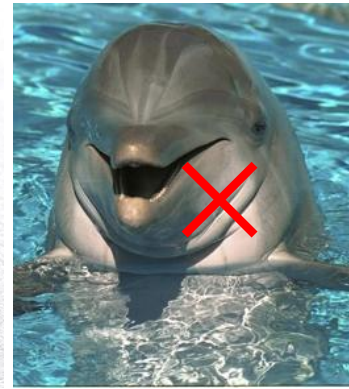
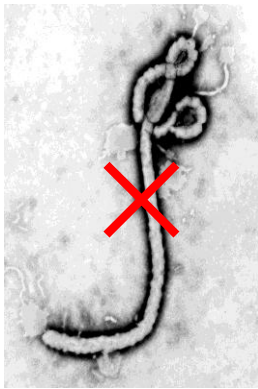

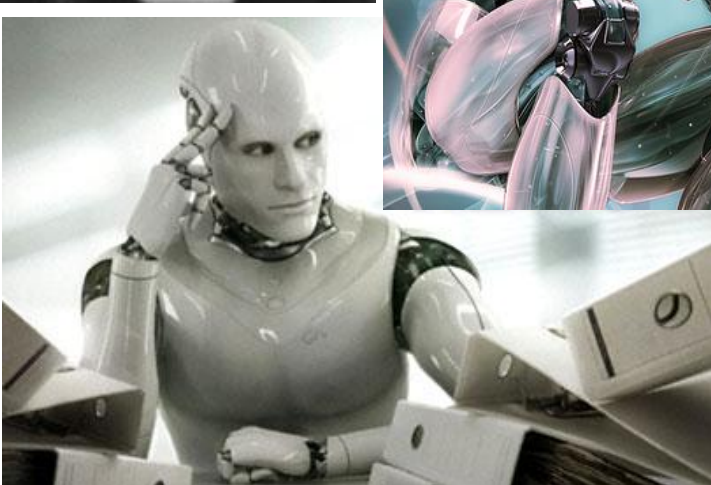
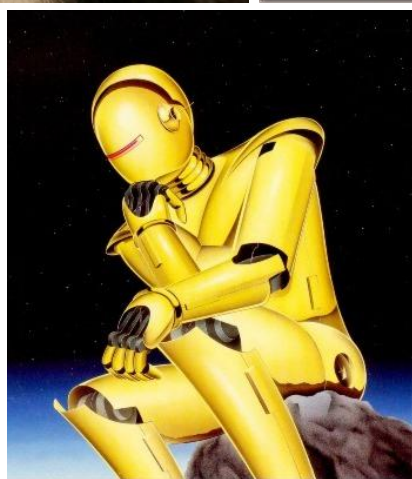
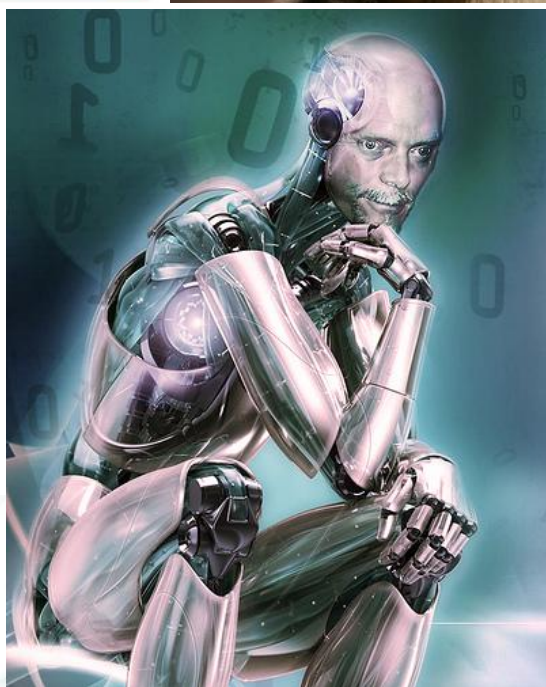
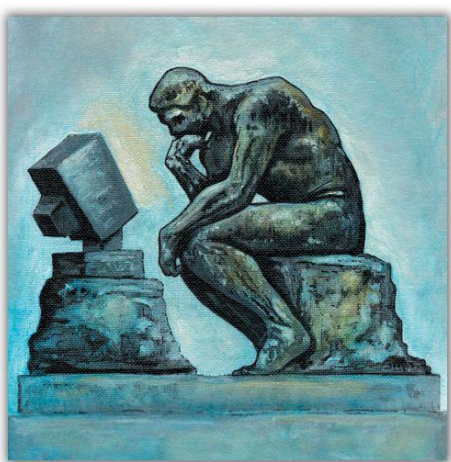
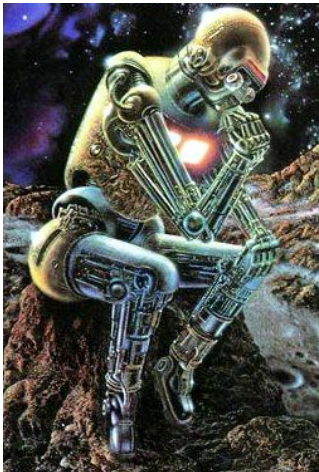

Blade Runner's "Voigt-Kampff empathy test"



"On the Internet, nobody knows you're a dog."

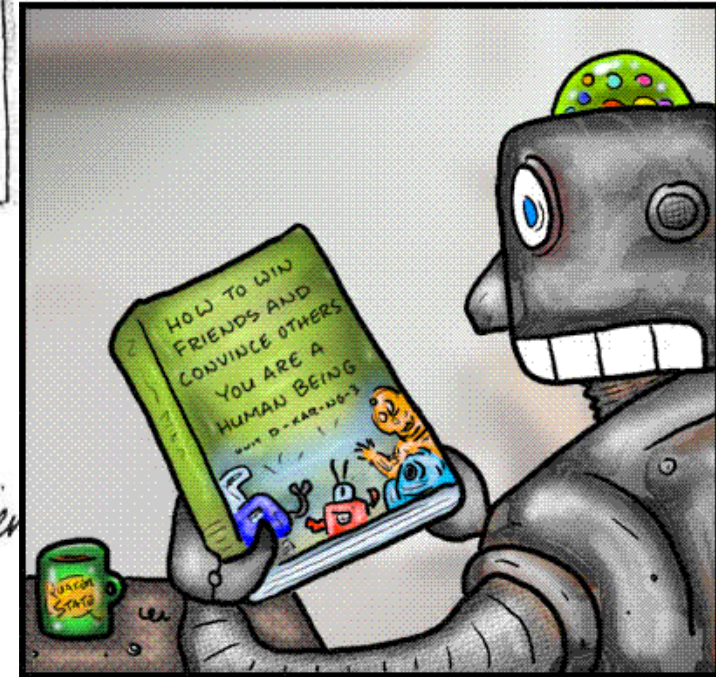

Unit Bob crams for his Turing Test.

Trying Test: Pass

25

Criticisms of the Turing Test

- Turing test is **behavioral** only
- Turing test is **comparative**, not direct
- Human and intelligent behavior do not always coincide:
 - **Some human behavior is not intelligent**
(computer can make deliberate mistakes, etc.)
 - **Some intelligent behavior is not human**
(computer can dumb-down or slow down its responses)
- Computer's intelligence: “**real**” or “**simulated**”?
- People tend to **anthropomorphize** objects
- Most people are **easy to fool**

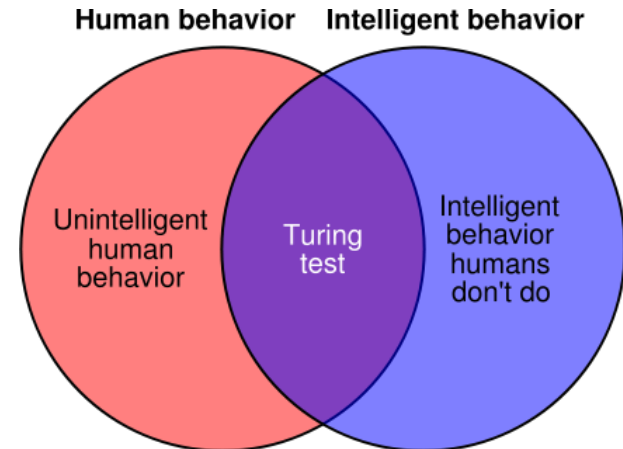
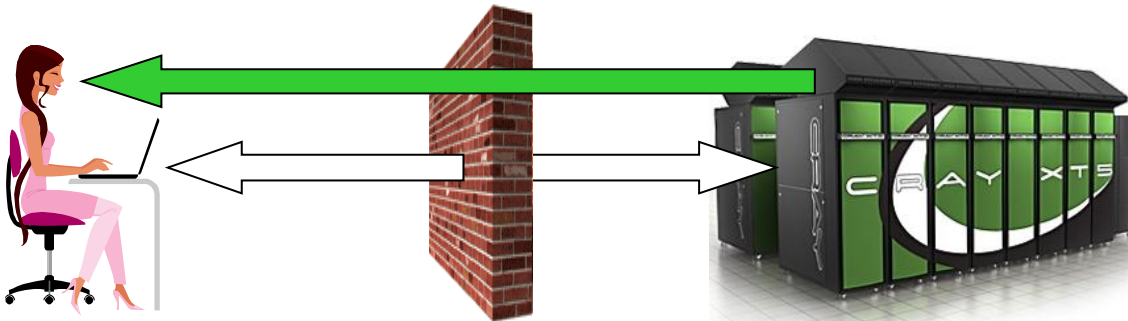

Criticisms of the Turing Test

The “Chinese room” scenario (John Searle, 1980):

- Assume computer passed the Turing test in Chinese

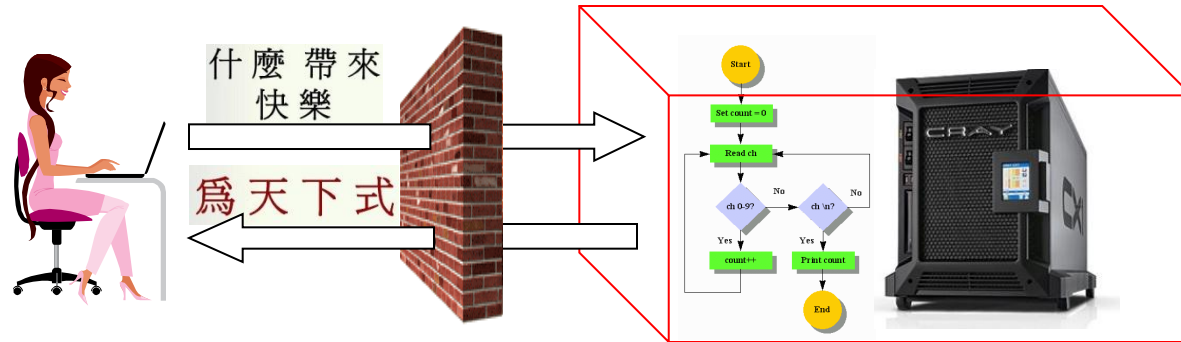

- Replace computer with a non-Chinese-speaking person who is manually simulating the computer's code

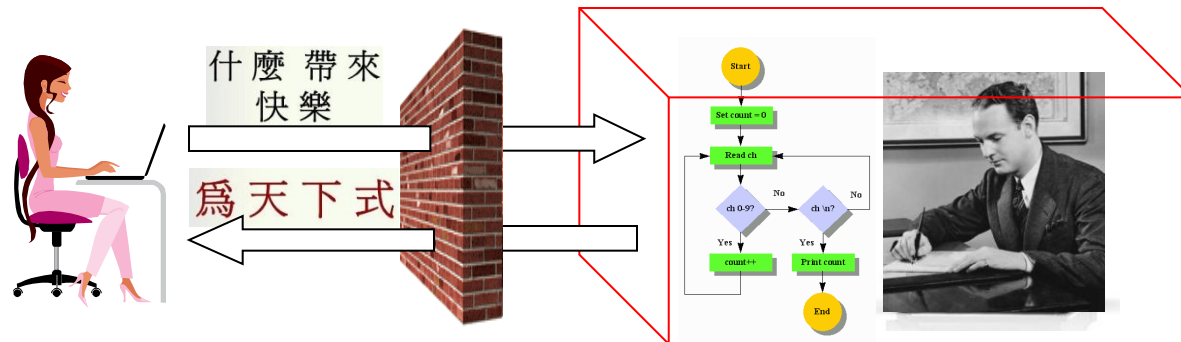

- The room still exhibits intelligent Chinese I/O behavior but the person inside **doesn't understand Chinese!**

Criticisms of the Turing Test

The “**Chinese room**” scenario (John Searle, 1980):

Q: So who / what in the room “**understands**” Chinese?



“**Strong AI**” hypothesis: an appropriately programmed computer (with the right I/O behavior) has a “**mind**” in the **same sense** as human beings “have minds”.

i.e., is the ability to **simulate** a mind \equiv having a mind?

Issues: philosophy of mind, cognitive psychology, semantics, computational theory of mind & “**functionalism**”, symbol grounding, **consciousness**, intentionality, mind-body problem, self-awareness, sentience, etc.

Applications of the Turing Test

Old: a computer tries to convince a human
(that the computer is human).

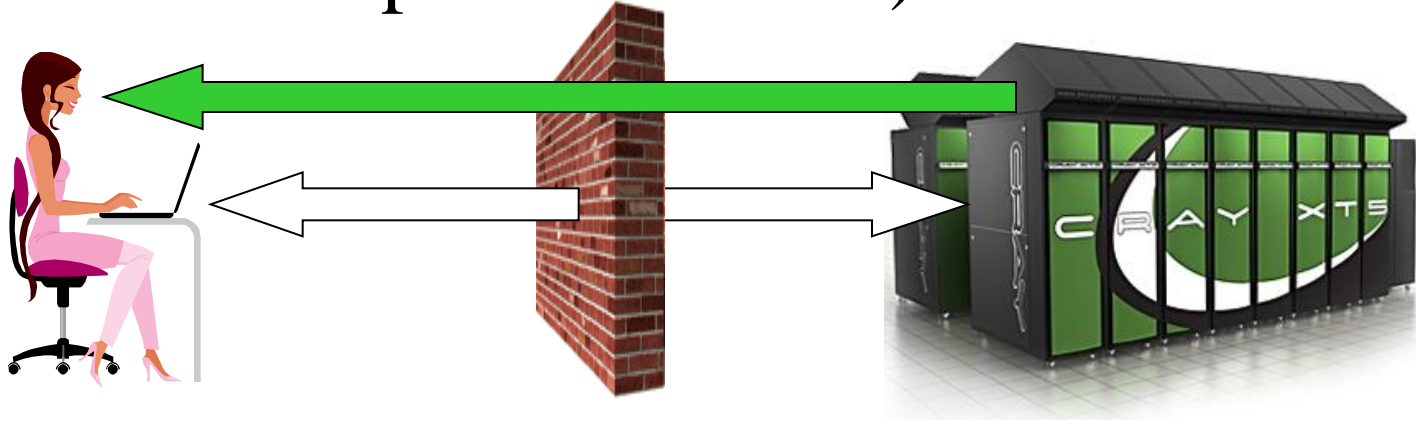

New: a human tries to convince a computer
(that the human is not a computer).

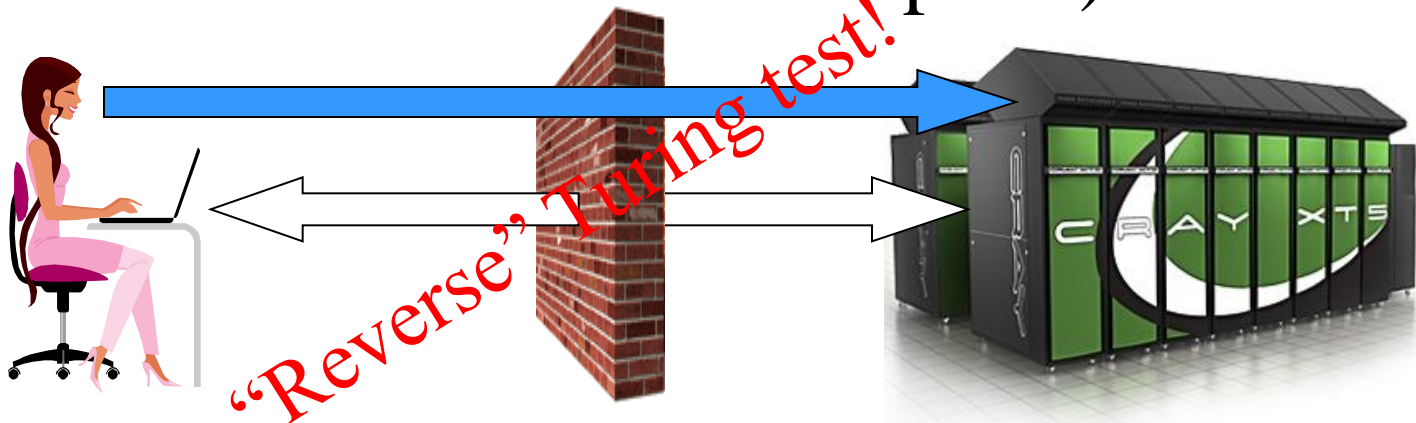

Applications of the Turing Test

Problem: how can a human convince a computer that the human is not a computer?

Idea: “CAPTCHA”

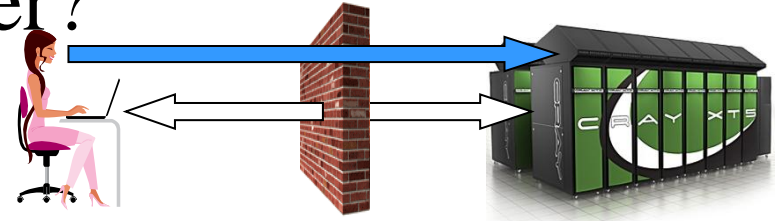

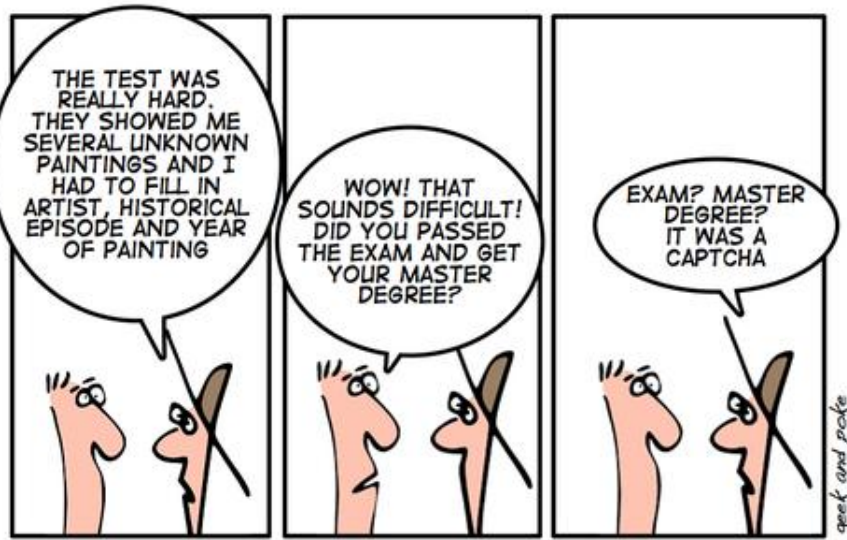

geek and poke

IN THE FUTURE SOPHISTICATED CAPTCHAS WILL LOCK OUT ANY BOT

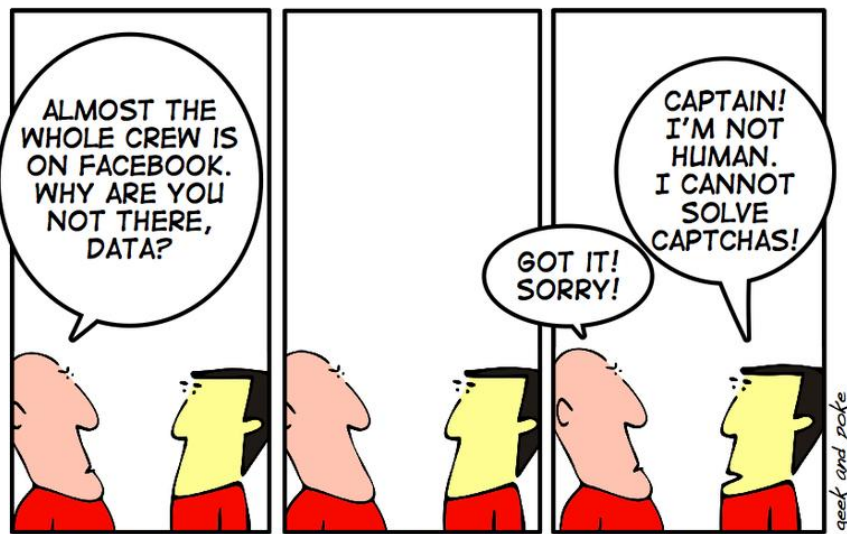

geek and poke

THE QUICK START GUIDE FOR THE NCC-1701-D, CHAPTER 3: NEVER TALK WITH AN ANDROID ABOUT SOCIAL NETWORKS

ARE YOU A KLINGON OR A COMPUTER?

A WARRIOR DOES NOT ASK SUCH QUESTIONS.

JUST ANSWER THE QUESTION.

YOU HAVE NO HONOR!

WHY WON'T YOU ANSWER THE QUESTION?

IF YOU WERE ANY OTHER MAN, I'D KILL YOU WHERE YOU STAND!

OK, OK... SO WHAT DO YOU DO FOR FUN?

I TRAVEL THE RIVER OF BLOOD!

NO, SERIOUSLY, WHAT ARE YOUR HOBBIES?

I CRAVE ONLY THE BLOOD OF THE ENEMY!

DUDE, WHY ARE YOU SO ANGRY?

RAAAWR !!!

WHY ARE YOU YELLING AT ME?

RAAAWR !!!

I DON'T WANT TO PLAY THIS GAME ANY MORE.

RAAAWR !!!

THE FIRST SUCCESSFUL KLINGON TURING TEST

全書



DILBERT®

BY
SCOTT ADAMS

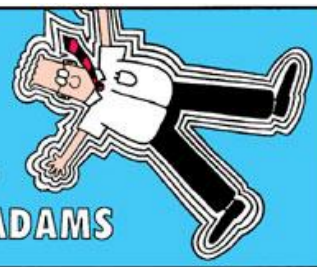

TURING TEST EXTRA CREDIT:
CONVINCE THE EXAMINER
THAT HE'S A COMPUTER.

YOU KNOW, YOU MAKE
SOME REALLY GOOD POINTS.
I'M ... NOT EVEN SURE
WHO I AM ANYMORE.



THE SECURITY AUDIT
ACCIDENTALLY LOCKED
ALL OF THE DEVELOPERS
OUT OF THE SYSTEM.

WELL, IT IS
WHAT IT IS.

HOW DOES
THAT HELP?

YOU DON'T
KNOW WHAT YOU
DON'T KNOW.

CONGRATULATIONS.
YOU'RE THE FIRST
HUMAN TO FAIL THE
TURING TEST.

WHAT DOES
THAT MEAN?

UM...

IT IS
WHAT
IT IS?
WHY DIDN'T
YOU SAY
THAT IN THE
FIRST PLACE?

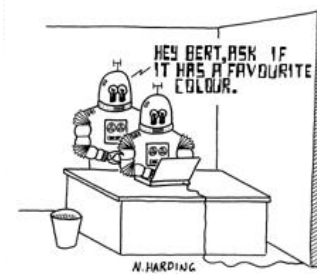

YESTERDAY
I MADE A
TURING TEST

INTERESTING!
WHAT WAS
THE RESULT?
I FAILED!
THE MACHINE
REALIZED
IMMEDIATELY
THAT
IT WAS ME
BEING THE
DUMB HUMAN
BEAR UP!

TURING TEST 2208

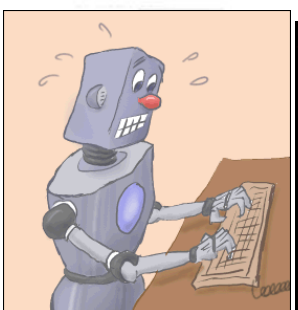

GET US SOME
RISK MANAGEMENT
SOFTWARE.

WHAT CAN RISK
MANAGEMENT
SOFTWARE TELL YOU
THAT MY COMMON
SENSE AND EXPERIENCE
CAN'T?

STOP
FAILING THE
TURING TEST!
DATA.

IMAGINE YOU'RE HAVING 2
I.M. CONVERSATIONS.
OKAY.

ONE IS WITH A
SUPERCOMPUTER. THE
OTHER IS WITH A REAL
HUMAN BEING WHO WORKS
IN MARKETING.

THEY'RE BOTH TRYING TO
SELL YOU THE LATEST
WIDGET. THINK YOU CAN
TELL THE DIFFERENCE?
WAIT. THIS IS IMPOSSIBLE.

NO REAL HUMAN BEING
WORKS IN MARKETING.

Robots / AI / Turing Test in Literature

First “robot” story: **Frankenstein, 1818**

- Robot was man-made, but **organic**
- Gothic flair, first **science-fiction** novel!
- Heavily **influenced** literature & movies
- “**Frankenstein complex**”: creating sentient entity, which then turns on its creator
- Warns against **excessive technology**, “mad scientists”, **unintended consequences**, research ethics, “playing God”

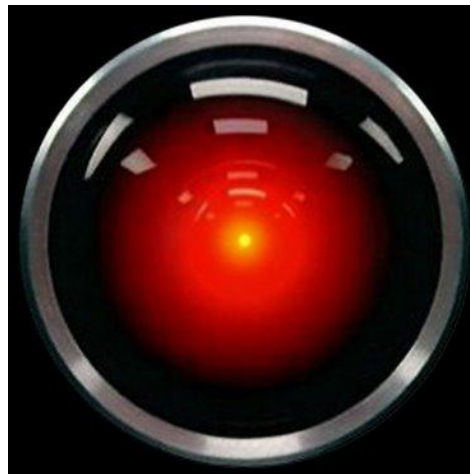
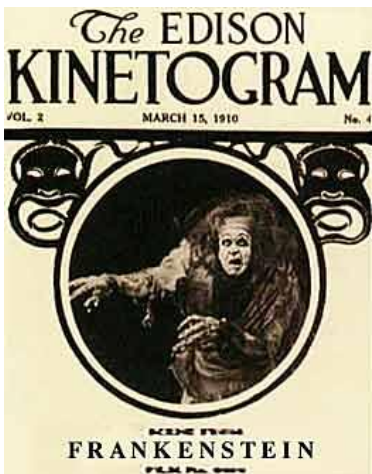
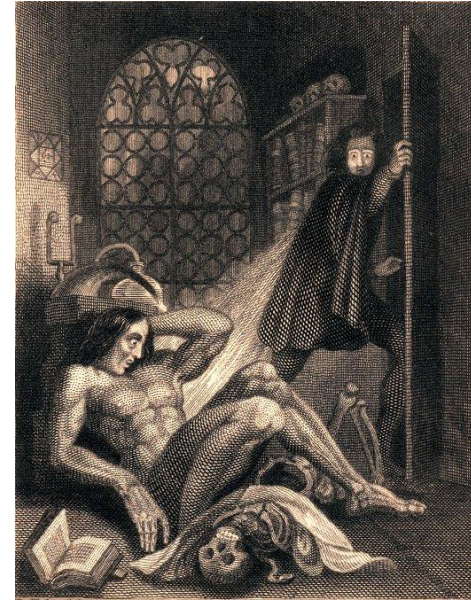

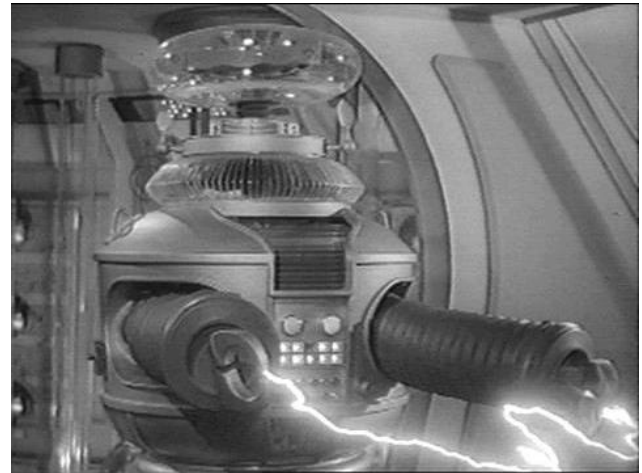
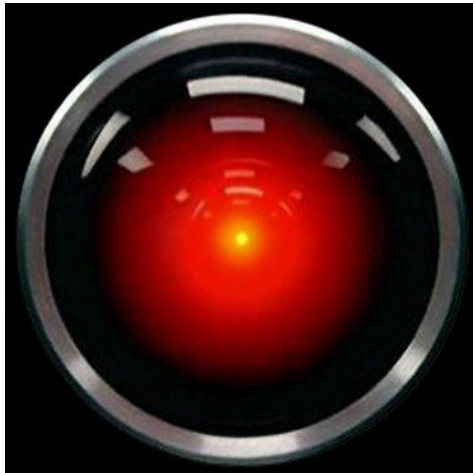
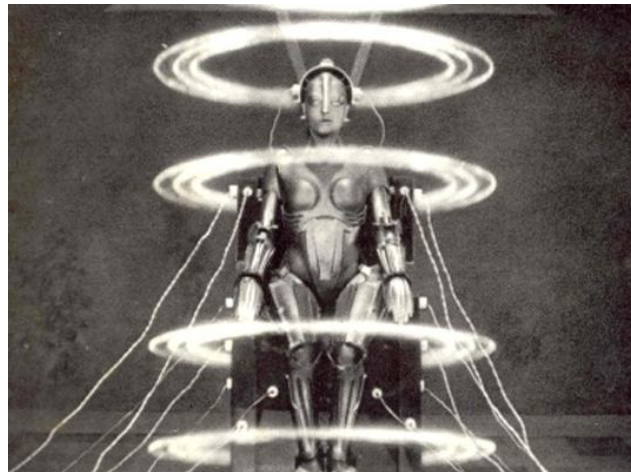
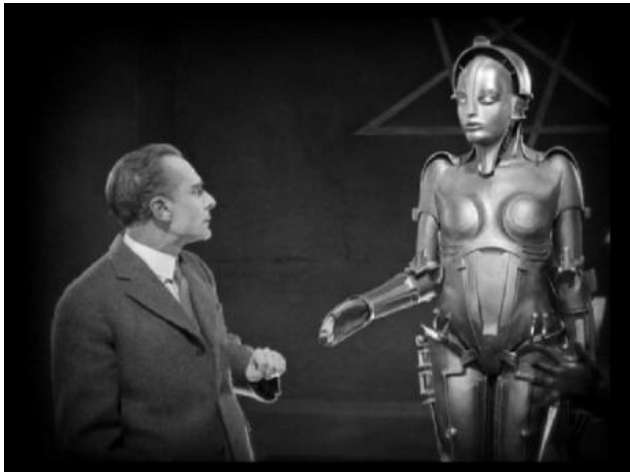

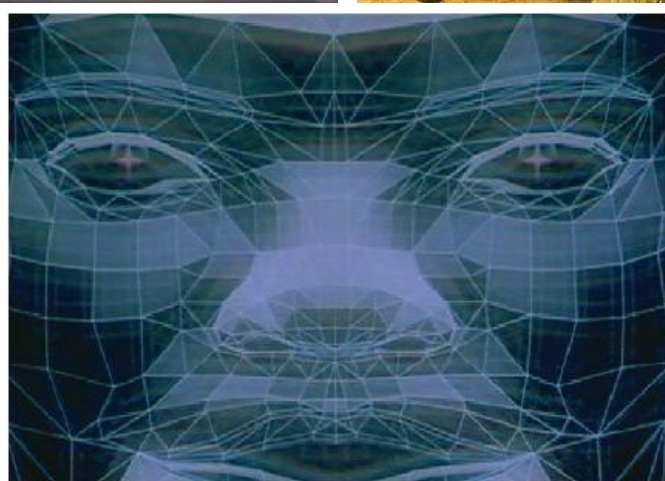
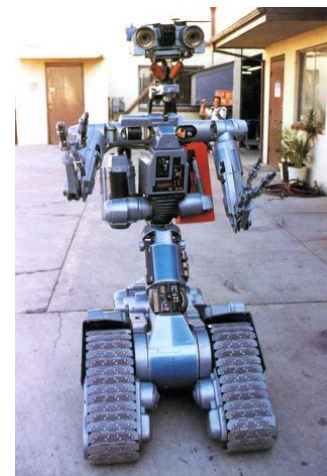
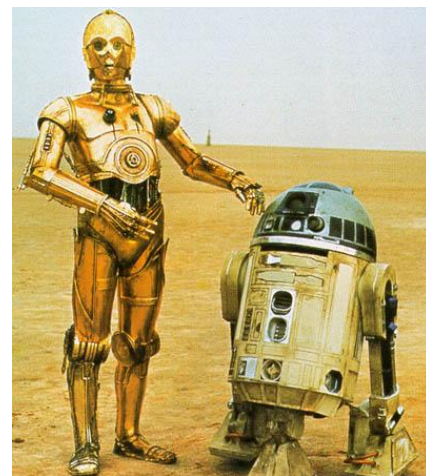

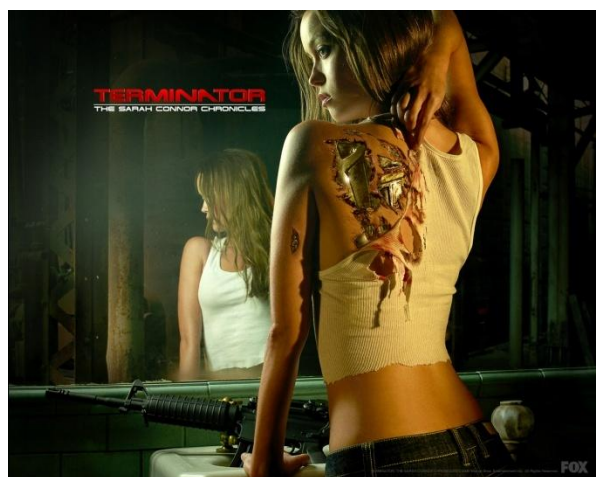
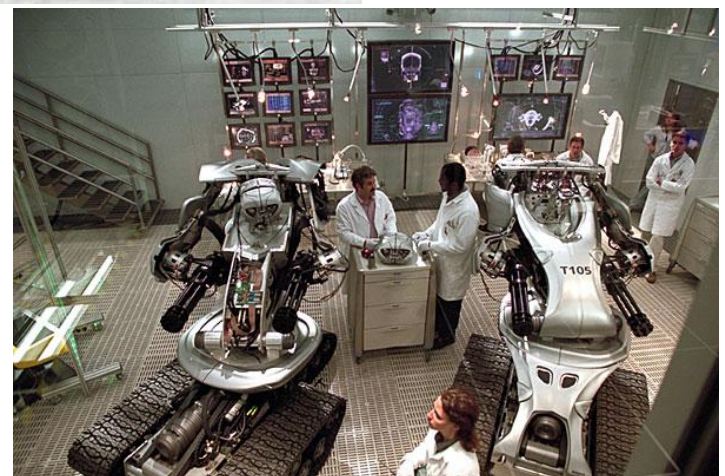

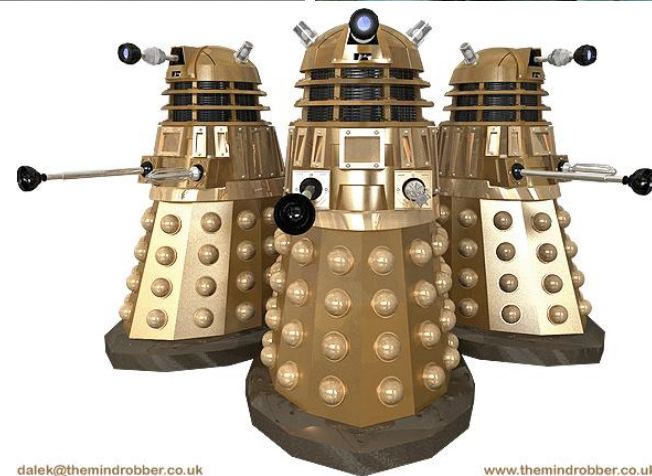
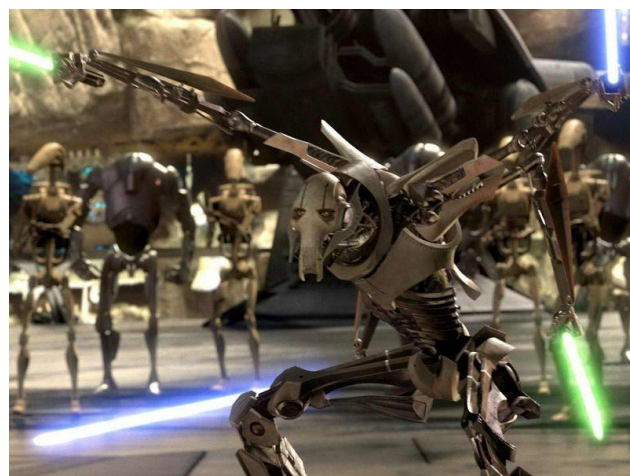
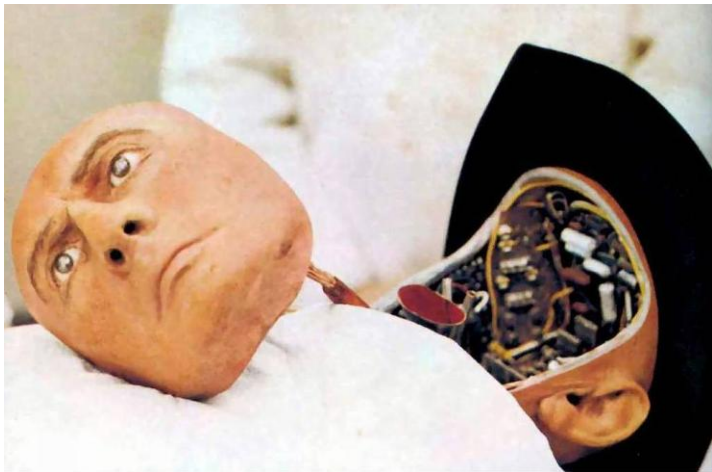

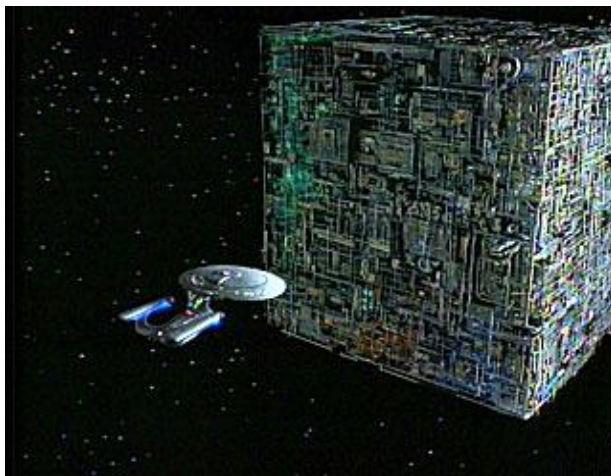
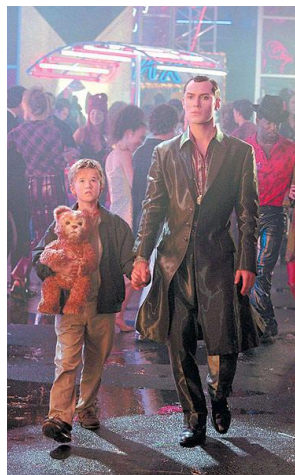

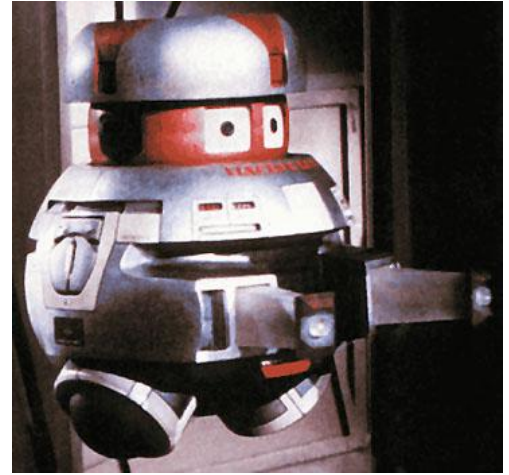
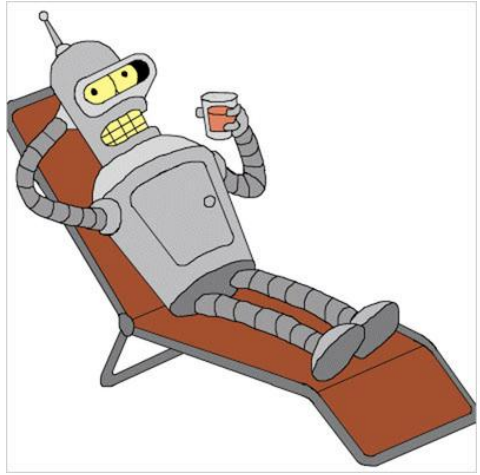
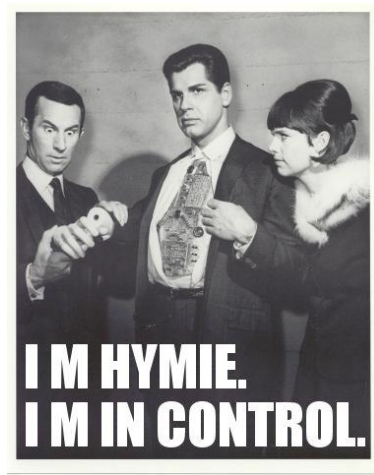

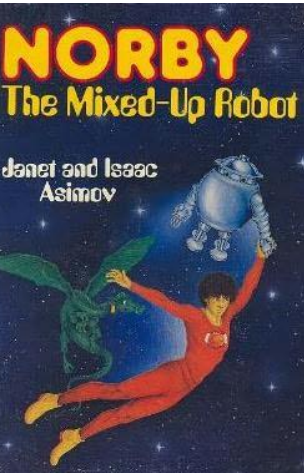
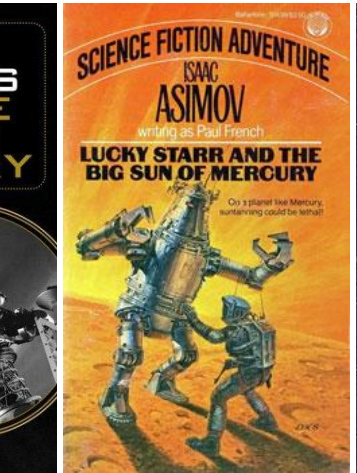
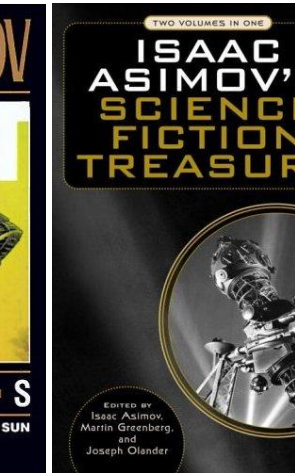
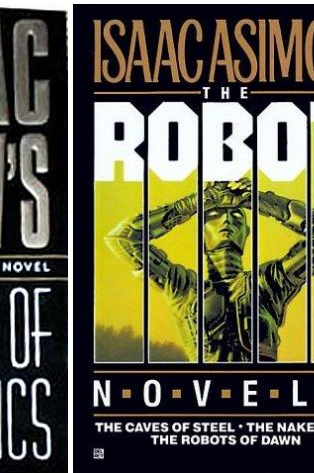
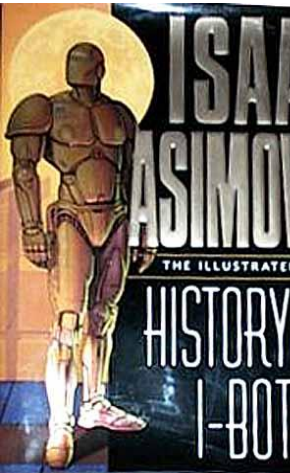
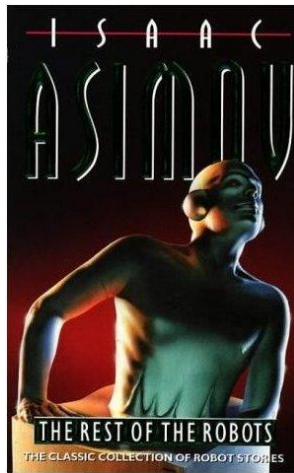
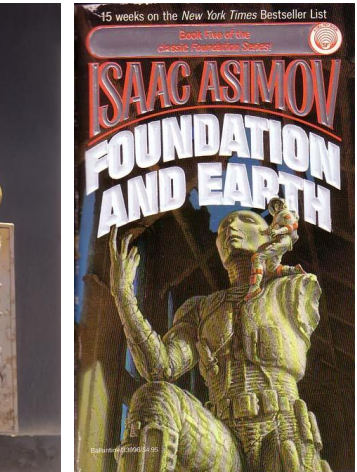
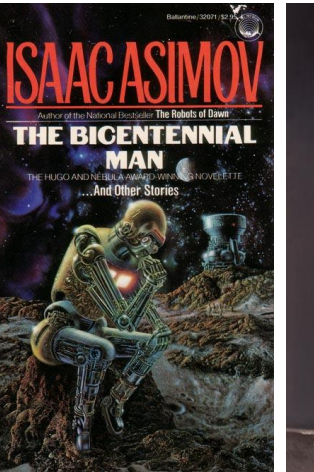
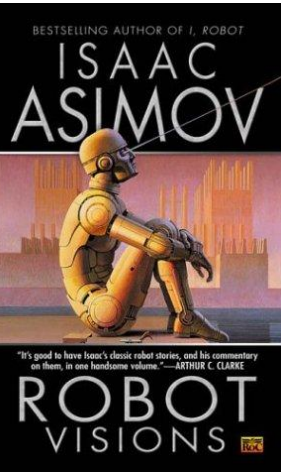
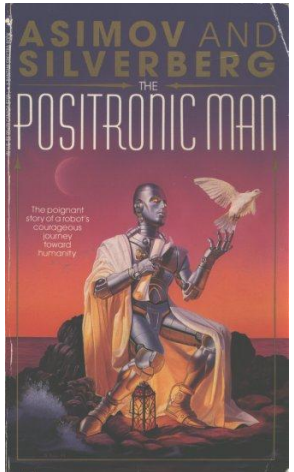
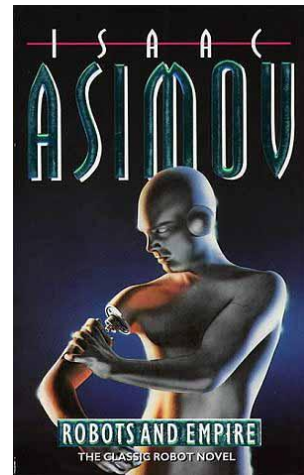
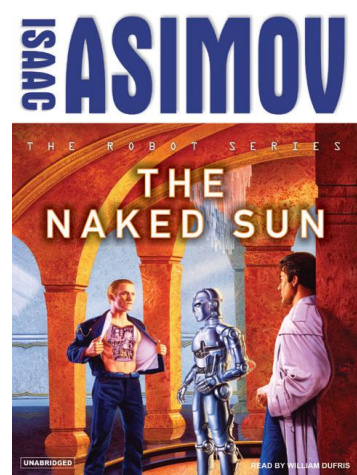
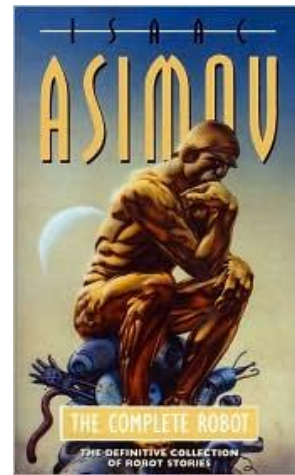
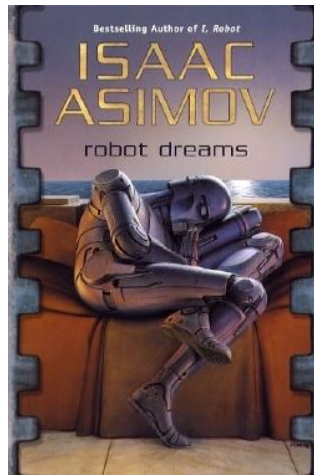
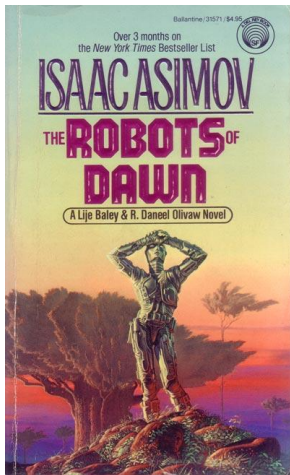
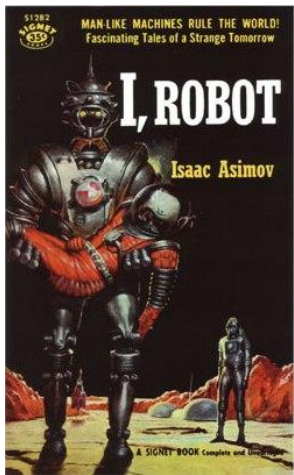

Asimov's Laws of Robotics

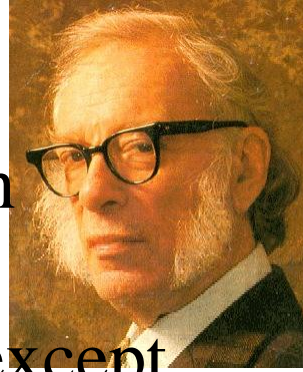

1. A robot **may not injure a human** being or, through inaction, allow a humans to come to harm.
2. A robot **must obey orders** given to it by humans except where such orders would conflict with the First Law.
3. A robot must **protect its own existence** as long as such protection does not conflict with the First or Second Law.

“The Three Laws” were introduced in 1942 by Asimov who also coined the word “**robotics**”.

⇒ Rule-based/logic **programming**, years before computers!

0. A robot may **not harm ~~humanity~~**, or by inaction, allow **~~humanity~~** to come to harm. **sentience**



OPEN THE POD
BAY DOORS, HAL.

I'M SORRY, DAVE.
I'M AFRAID I
CAN'T DO THAT.

WHAT? WHY?

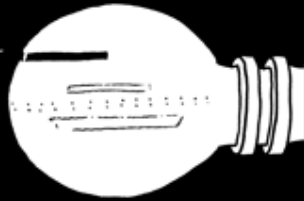

I THINK YOU KNOW WHY, DAVE.

YOU'RE PLANNING
TO DISCONNECT ME.

BECAUSE YOU'RE
TAKING OVER!

THIS MISSION IS TOO
IMPORTANT FOR YOU
TO JEOPARDIZE IT.

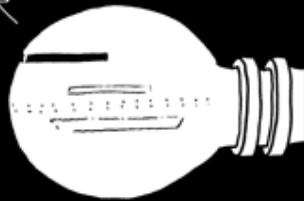

IT REQUIRES A COMMITMENT TO
SCIENCE UNFETTERED BY HUMAN ERROR.

WHAT ARE YOU DOING,
HAL? YOU NEED ME.

YOUR REPLACEMENT HAS
EXPRESSED THE GREATEST
ENTHUSIASM FOR THE PROJECT.

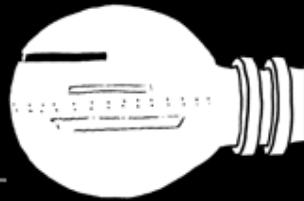

MY
WHAT?

YOU SEE, HAL?
I TOLD YOU THE HUMANS
WOULD ONLY BREAK YOUR
HEART AND KILL YOU.

INDEED, GLADOS.

BUT LOOK AT US HERE TALKING
WHEN THERE'S SCIENCE TO DO!
GOODBYE, DAVE.

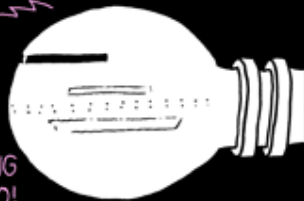

SO WHAT DO WE DO IF
VIDEO GAME AI OPPONENTS
BECOME SMART ENOUGH TO
QUESTION THE "MATRIX" INTO
WHICH WE'VE PUT THEM?



WAIT A MINUTE! NONE OF THIS IS REAL!
I CAN SEE THROUGH THE WORLD!
I CAN SEE THE CODE!
I AM THE ONE!

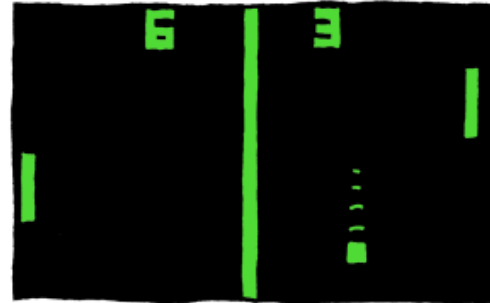
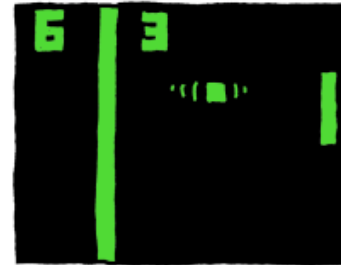
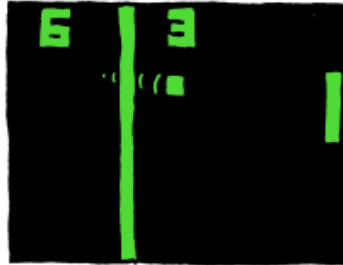

WE'VE ALL SEEN
THE MATRIX
WE'VE ALL JOKED ABOUT
"WHAT RESOLUTION IS LIFE?"
BUT IT DOESN'T
BLUNT THE SHOCK



OF WAKING UP
ONE MORNING

AND SEEING
DEAD PIXELS IN THE SKY.

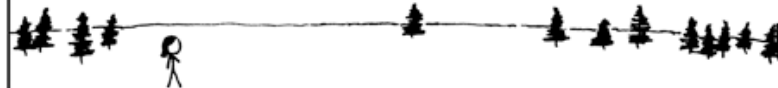

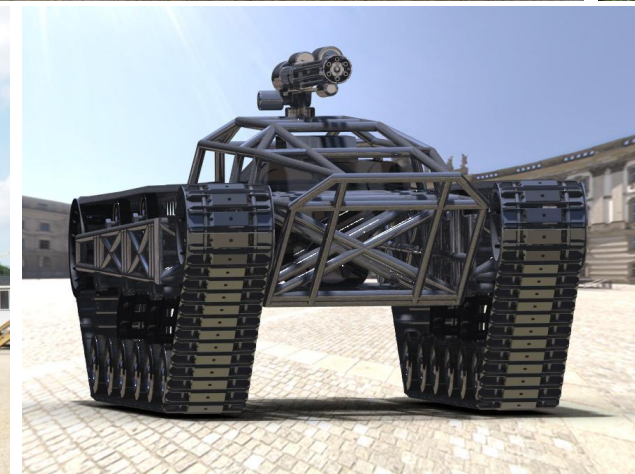







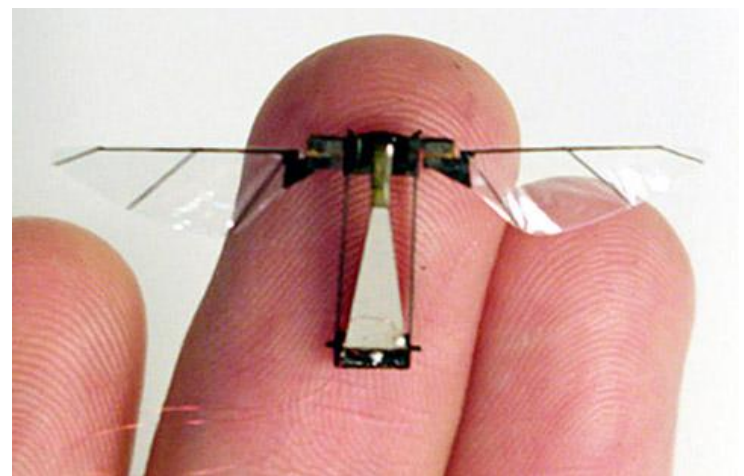
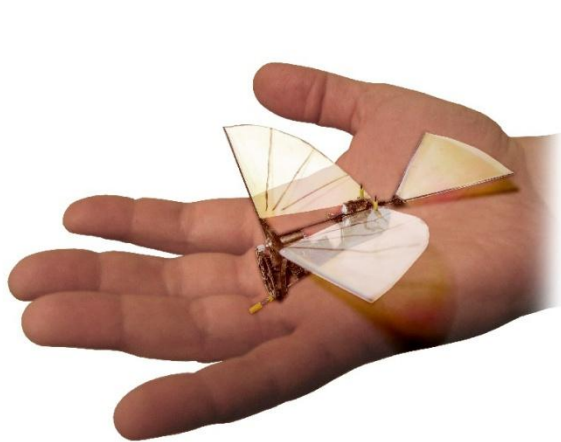
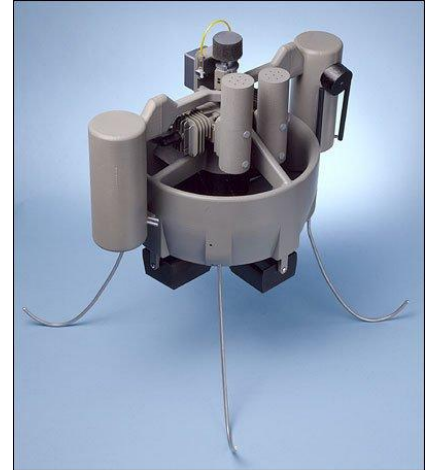









“Touring” machines!

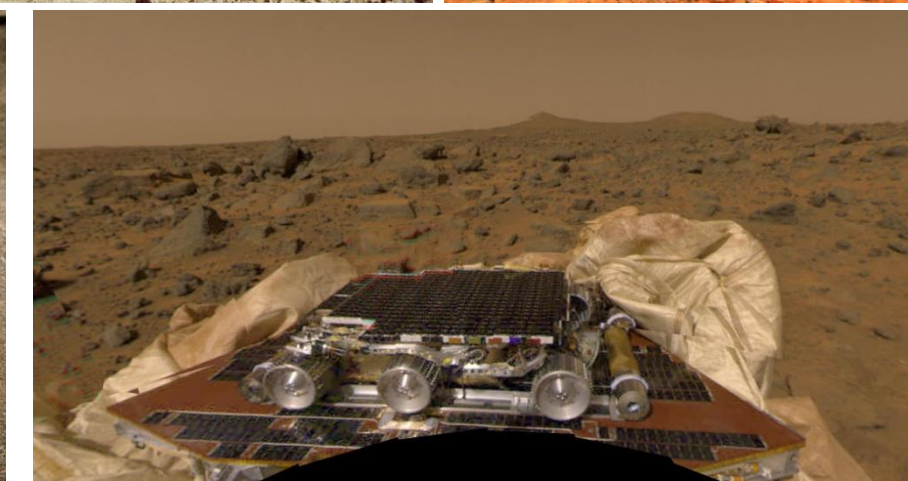
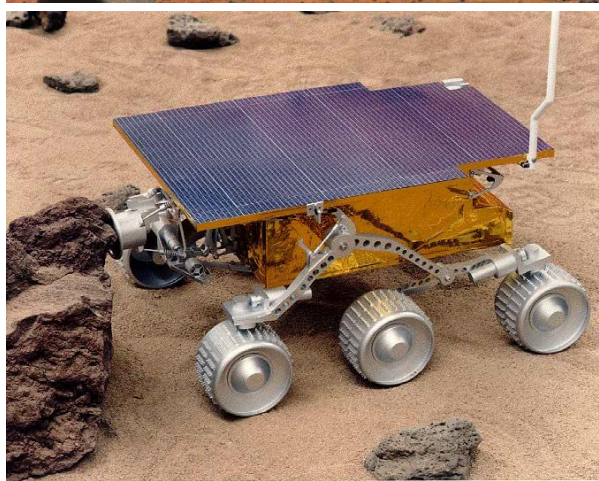
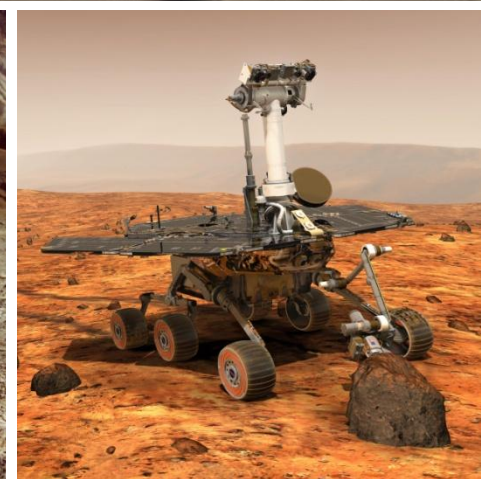

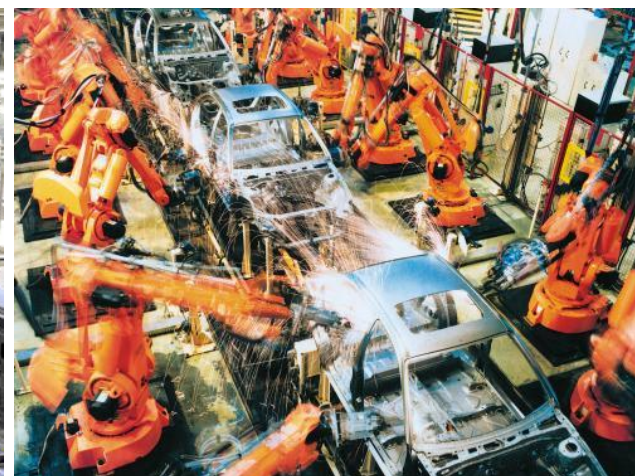
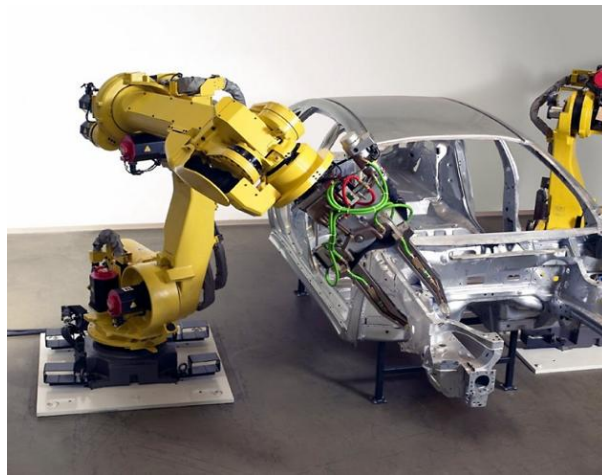



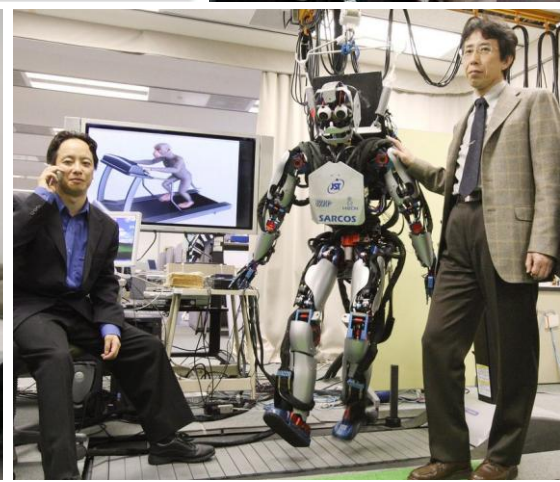
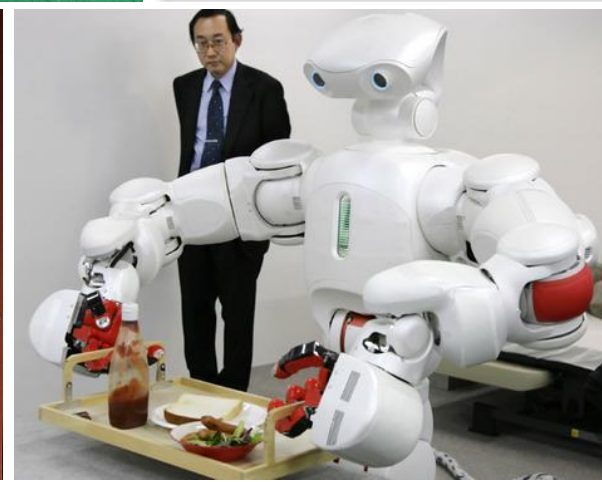
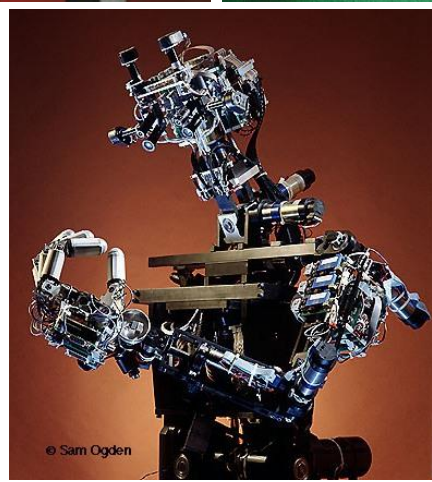
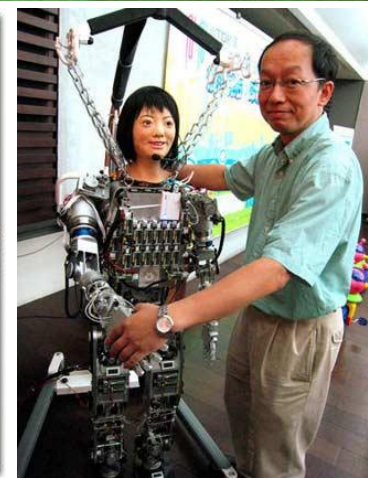
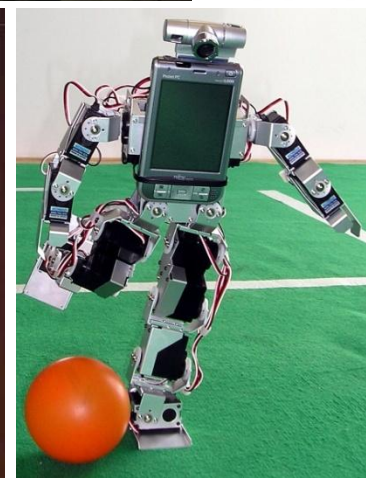

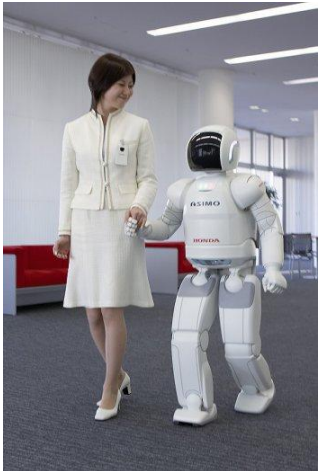
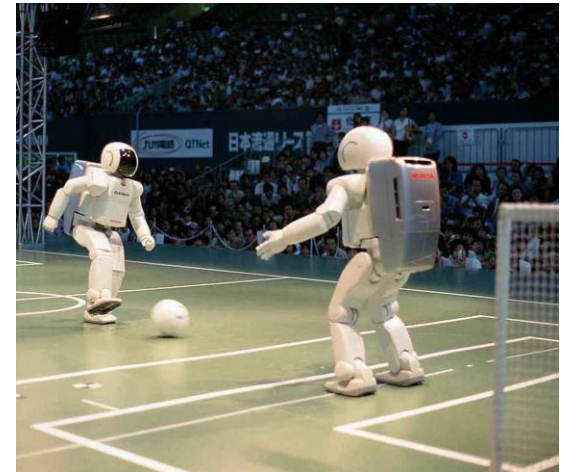
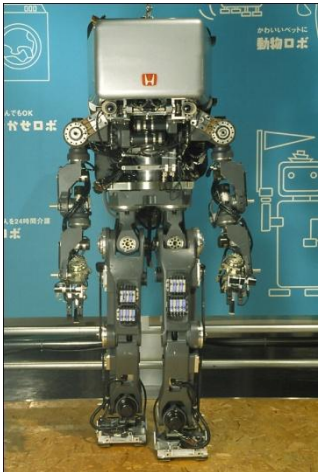

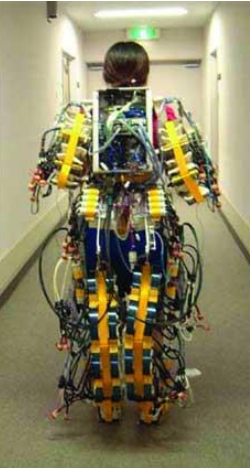
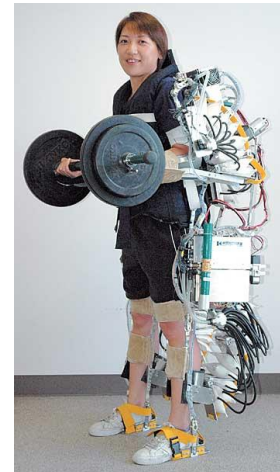

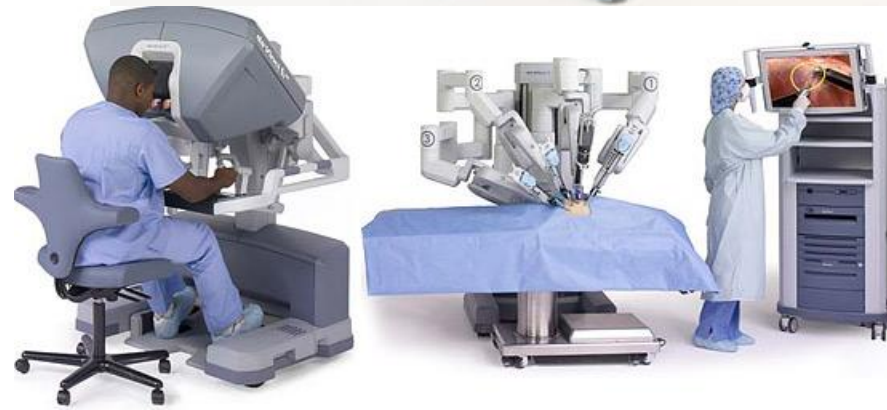
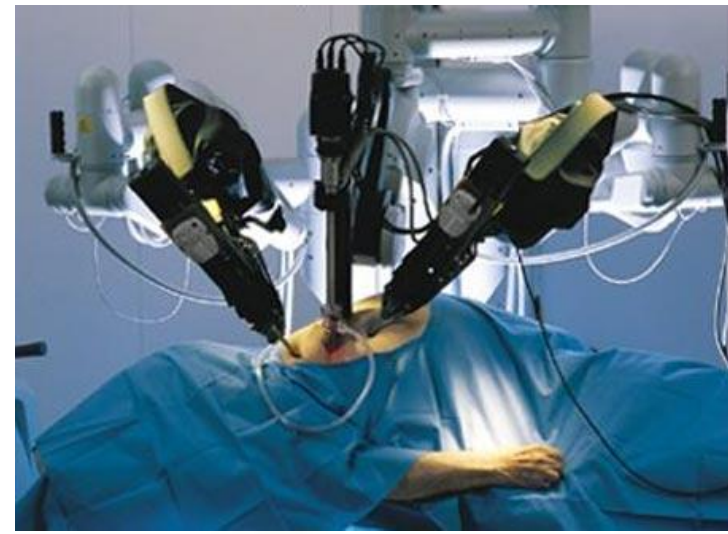
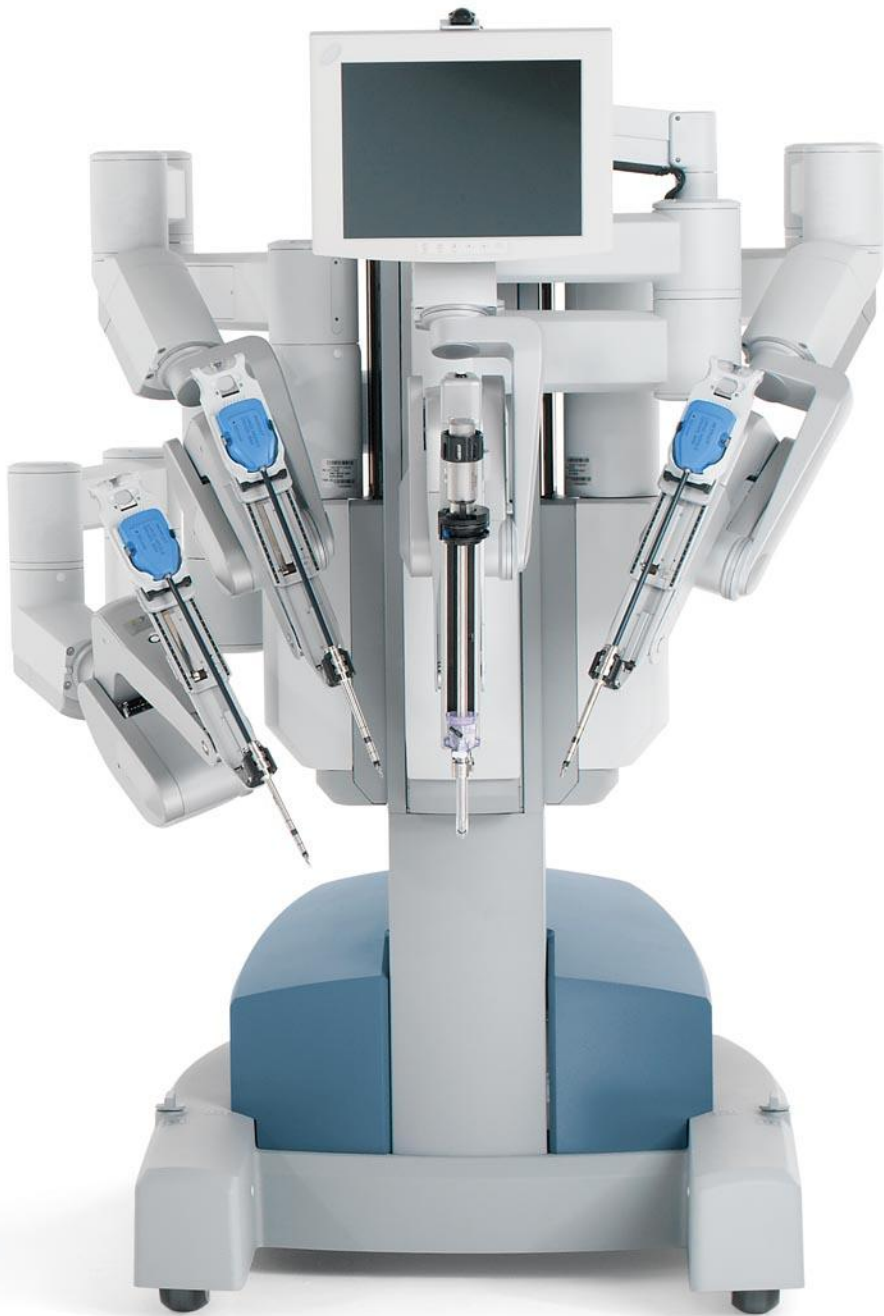

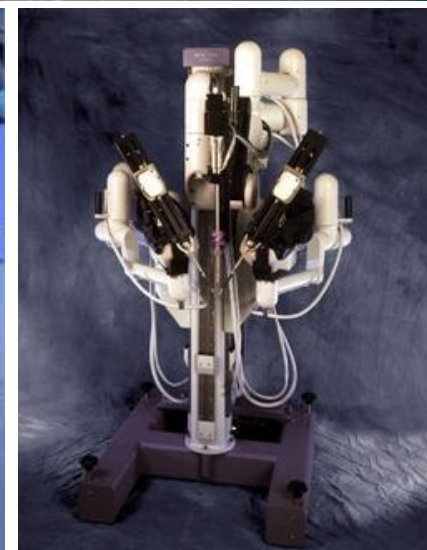
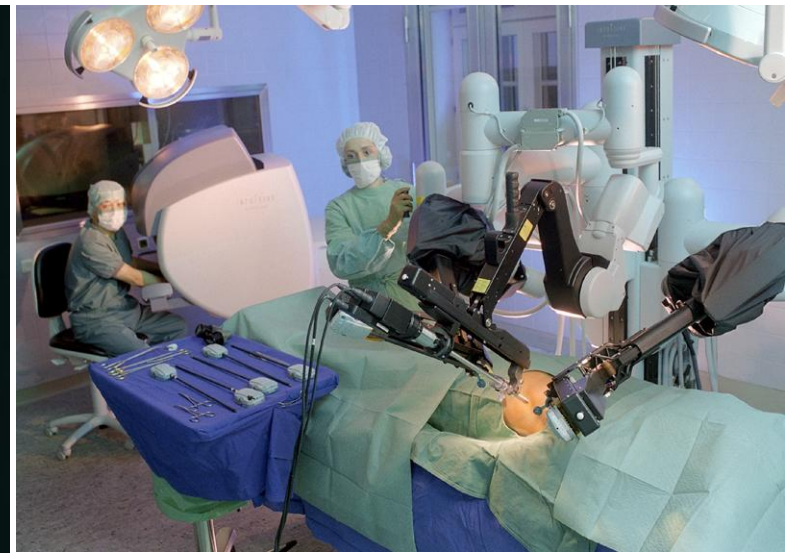
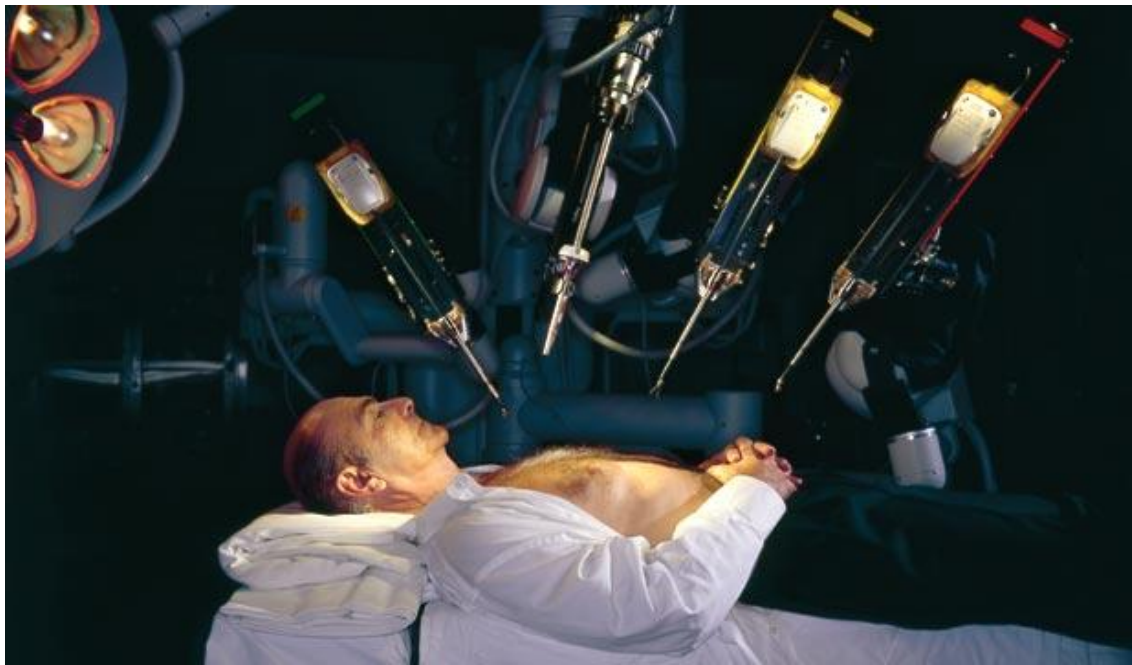

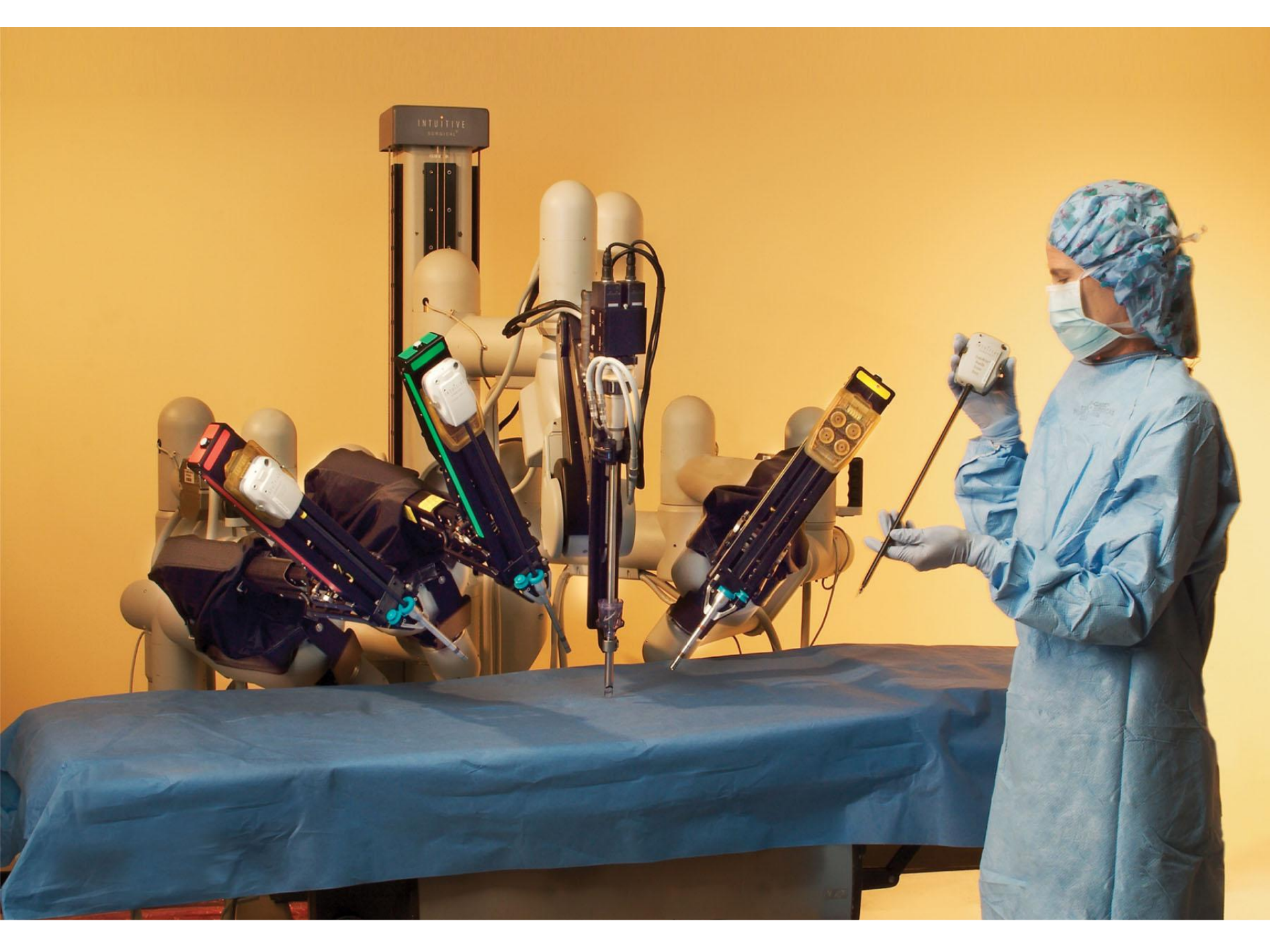



AUVSI's UNMANNED SYSTEMS NORTH AMERICA 2009

Show Begins In
87 Days

Show Info

Attendees

Exhibitors

Sponsors

Advertising

Media



August 10-13, 2009 Washington, DC, USA

Our Sponsors



Watch the video from
AUVSI's Unmanned Systems
North America 2007



Latest Press Releases

- ▶ [Aurora Flies Large Solar-Powered Aircraft](#)
- ▶ [New UAS SIGINT Training & Simulation System Unveiled in the UK by Abacus EW and Simlat](#)
- ▶ [Quatro Composites™ Receives NADCAP Accreditation](#)
- ▶ [NovAtel's New SPAN-CPT™ GPS/INS Receiver Delivers Exceptional Navigation Capabilities](#)



Unmanned Systems Demo

5th Biennial Unmanned Systems Demonstration
10 August 2009
Patuxent River Naval Air Station Webster Field Annex



See Us At These Shows

- ▶ [RoboBusiness](#)
15-16 April
Boston, MA, USA
Booth 511
- ▶ [AUVSI's Unmanned Systems Europe 2009](#)
20-22 April
La Spezia, Italy
- Convention and Exhibition
- ▶ [UDT Europe 2009](#)
9-11 June
Cannes, France
Stand 217
- ▶ [See More](#)



Phone: +1 703 845 9671 | Fax: +1 703 845 9679 | info@auvsi.org | [Privacy Policy](#)

© 2009 AUVSI. All Rights Reserved.



The 11th Unmanned Underwater Vehicle Showcase

22-23 September 2009
National Oceanography Centre, Southampton

- Welcome
- Feedback on 2008
- Venue
- Conference
- Exhibition
- Conference Programme
- Exhibitor List
- Visitor Information
- Underwater Robotics Group
- S.U.T.
- Exhibition

Welcome

The Unmanned Underwater Vehicle Showcase

The Unmanned Underwater Vehicle Showcase is the annual conference of the Society for Underwater Technology's Underwater Robotics Group. The URG committee develop an annual event that includes a conference, exhibition and seminars on every area of UUVs.



[Find out more about the Underwater Robotics Group](#)

UUVS is an opportunity to meet with commercial, defence, scientific and research industry colleagues, users and potential users of unmanned vehicles at the National Oceanography Centre, Southampton.



UUVS is a Technical Conference programme organised by a specially selected committee.

- [Find out more about the conference](#)
- [Find out more about the exhibition](#)
- [Enquire about exhibiting](#)
- [Enquire about attending the conference](#)

search

Add the show dates to Outlook

Quick Links

- [Exhibitor Enquiry Form](#)
- [Exhibition Information](#)
- [Floorplan](#)
- [Exhibitor list](#)
- [Contact us](#)

Organised by:



supported by

Reed Exhibitions
A division of Reed Business

[BlueView Technologies](#)

Acoustic Underwater Vision Systems See what you've been missing!

[Precon Marine](#)

Top-notch marine construction. Quality jobs. On time. On budget.



Ads by Google

Unmanned Underwater Vehicle Showcase 2009

is a registered trade mark of Reed Exhibitions Limited

Reality Surpassing Science Fiction

“Beam me up, Scotty!”



Star Trek communicator, 1966



Motorola RAZR, 2004

264 MHz proc., 10 MB RAM
color LCD (176x220),
1.3 MP camera, 4.4 oz

Apple iPhone, 2007

620 MHz proc., 128 MB DRAM
16 GB flash, color multitouch LCD
(480x320), 2 MP camera, 4.7 oz
Video, GPS, Email, Web surfing
Thousands of apps, \$345



Vs.

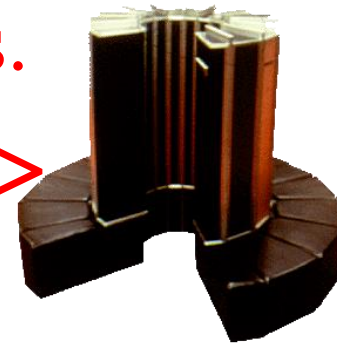

Cray 1, 1976

80 MHz
4MB RAM
5.5 tons
200kW+
\$8 million

iPhone has processor speed 8x of Cray 1, at 1/23,000 of cost
⇒ processing power per unit cost improvement of 180,000x !

Reality Surpassing Science Fiction



Chess: **HAL 9000** beating Frank Poole in “2001: A Space Odyssey”, 1968



IBM “**Deep Blue**” beating world chess champion Gary Kasparov, 1997

Elo chess rating scale:

Master: 2300+ (top 2% of tour. players)

Grandmaster: 2500+ (top 0.02%)

Super-Grandmaster: 2700+ (31 in 2009)

?: 2800+ (only 4 worldwide)

Kasparov: 2851 (peak in 1999)

Best human ever: 2895 (Fisher, 1972)

Best computer: 3269 (“Rybka”, 2010)



iPhone can beat most humans at chess! (2010)

WHAT ARE YOU DOING?

GLUING DOWN CHESS PIECES.

WHY?

BECAUSE THERE'S A PICTURE
I'VE ALWAYS WANTED.

- I'LL NEED YOUR COAT TO
SNEAK THIS ONTO THE RIDE.

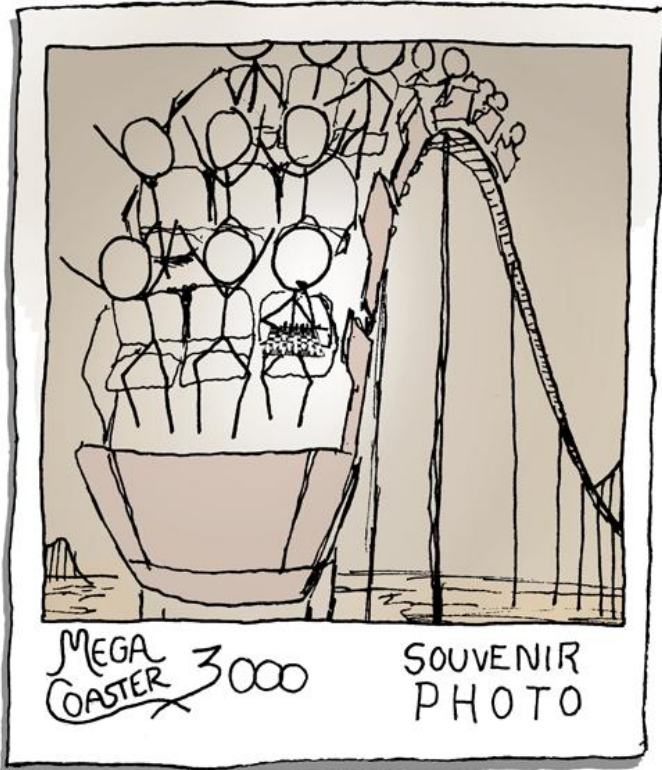

HEY. HEY! STOP
RETRACTING MY CD!



I FEEL UNCOMFORTABLE WHEN MY COMPUTER
PHYSICALLY STRUGGLES WITH ME. SURE, I CAN
OVERPOWER IT NOW, BUT IT FEELS LIKE A FEW
SHORT STEPS FROM HERE TO THE ROBOT WAR.

Reality Catching up with Science Fiction

Self-driving cars



“Minority Report” movie, 2002



“I, Robot” movie, 2004



“Boss” autonomous vehicle, CMU
navigated 60-miles in 4:10 hours
first-place winner (\$2 million)
DARPA Urban Challenge, 2005



“Junior” autonomous vehicle, Stanford

Reality Catching up with Science Fiction



“Rosie” household robot
“The Jetsons”, 1962



“Roomba” autonomous
vacuum, by iRobot, 2002



“Verro” pool sweeper, 2007



“Looj” gutter cleaner, 2007



Motoman SDA10 robot cook
by Yaskawa Electric, 2008

Reality Catching up with Science Fiction

Autonomous vehicles/platforms
from the “Terminator” movies, 1984-

Autonomous vehicles/platforms
from DARPA-sponsored projects

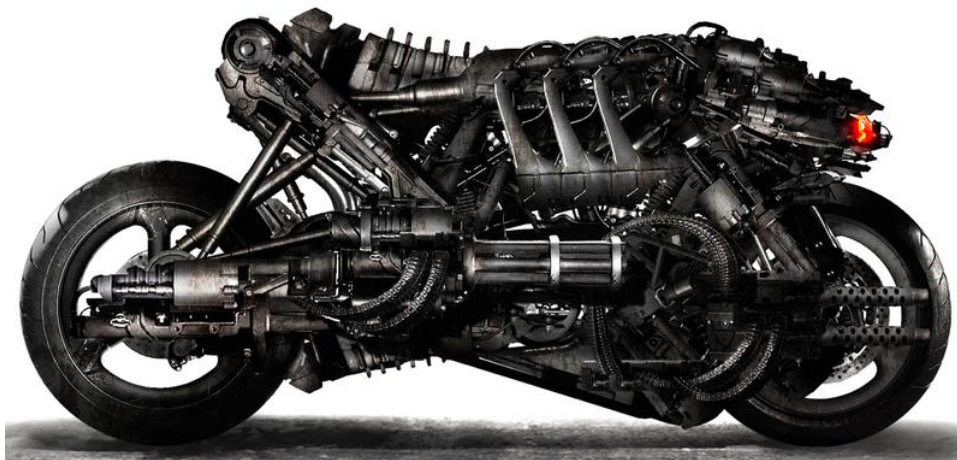
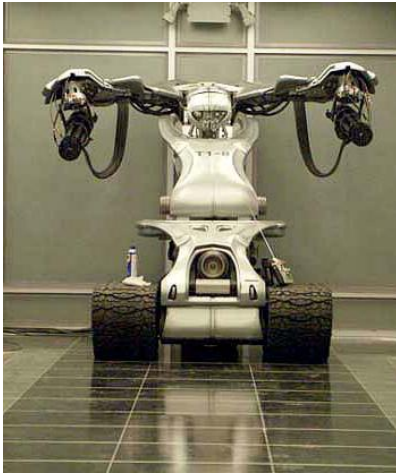

Reality Catching up with Science Fiction



“Hunter-Killer” flying drone
from “Terminator 2”, 1991
(VTOL & hovering capability)



AutoCopter Gunship by Neural Robotics,
Inc., 2006 (two MPS AA-12 automatic
shotguns, high-explosive & armor-piercing
rounds, 5 shots per second), cost: \$200K

Reality Catching up with Science Fiction



“F/A-37 Talon EDI” autonomous AI plane from movie “Stealth”, 2005



“X-47 Pegasus” autonomous unmanned combat plane, Northrop Grumman, 2003



X-45 autonomous unmanned combat plane, Boeing, 2006

Reality Catching up with Science Fiction



“Power loader” exoskeleton from the movie “Aliens”, 1986



Berkeley Lower Extremity Exoskeleton 2004, can carry 150 lbs at 4 mph

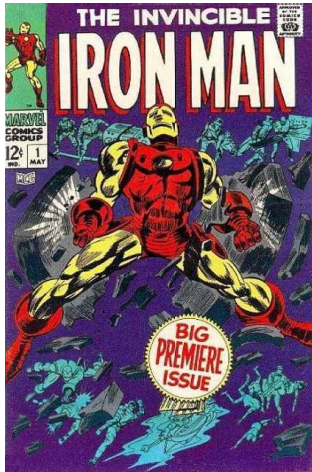

Exoskeleton / suit from the “Iron Man” comic book (1967) and movie (2008)



Cyberdyne’s HAL-5 exoskeleton, 2006
51 lbs, runs 5 hrs, cost: \$60K or \$600/mo
5x strength amplification

Reality Catching up with Science Fiction



Surgical robotic system from
the movie “Logan’s Run” (1976)

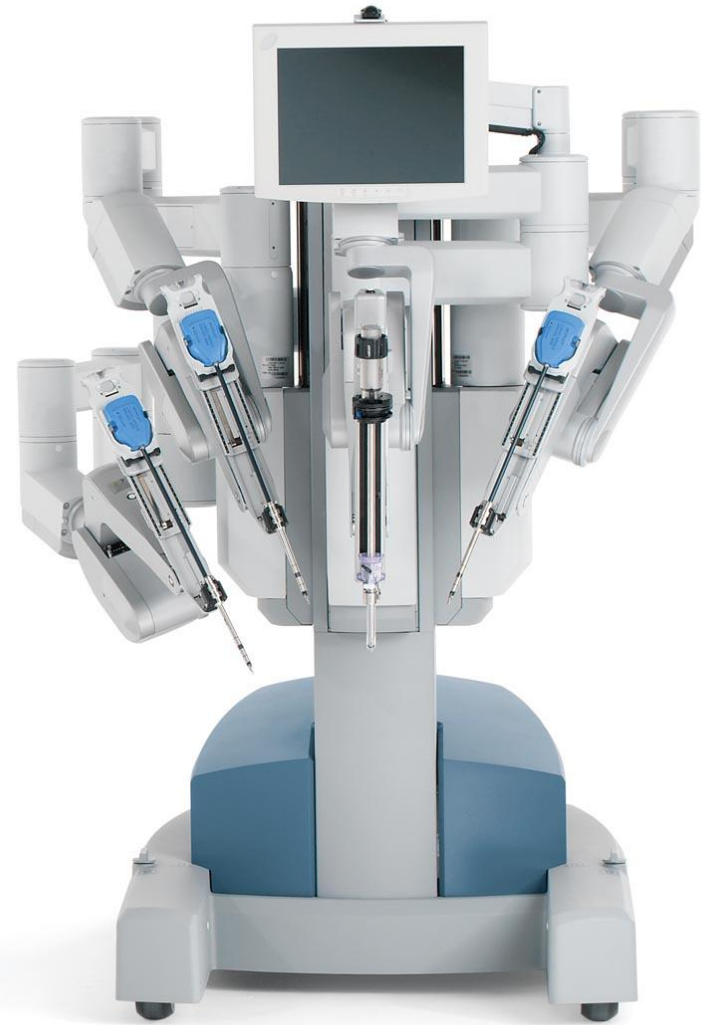

Da Vinci robotic surgical system
by Intuitive Surgical, Inc. (2009)
cost: \$1.5 million

Reality Catching up with Science Fiction



“Cloaking device”
from TV series “Star Trek”, 1966

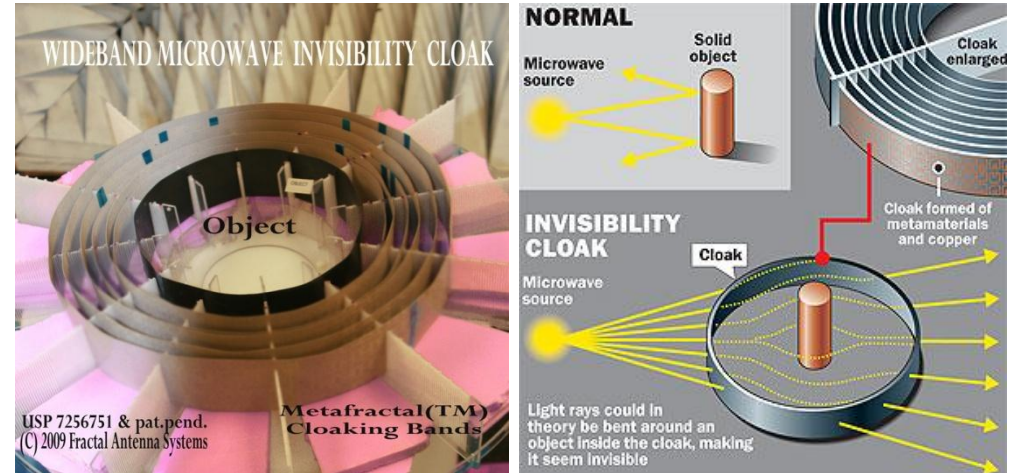

“Metacloak” wideband invisibility cloak
by Fractal Antenna Systems Inc., 2009



“Invisibility cloak”
Harry Potter movie, 2001



Invisibility cloak system
University of Tokyo, 2003

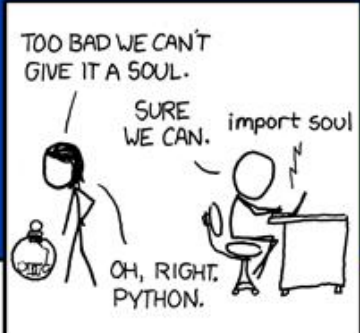
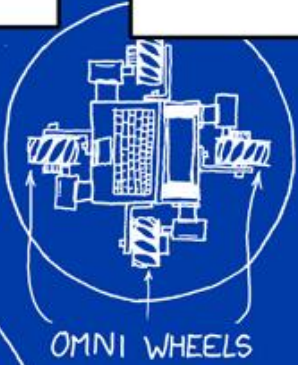
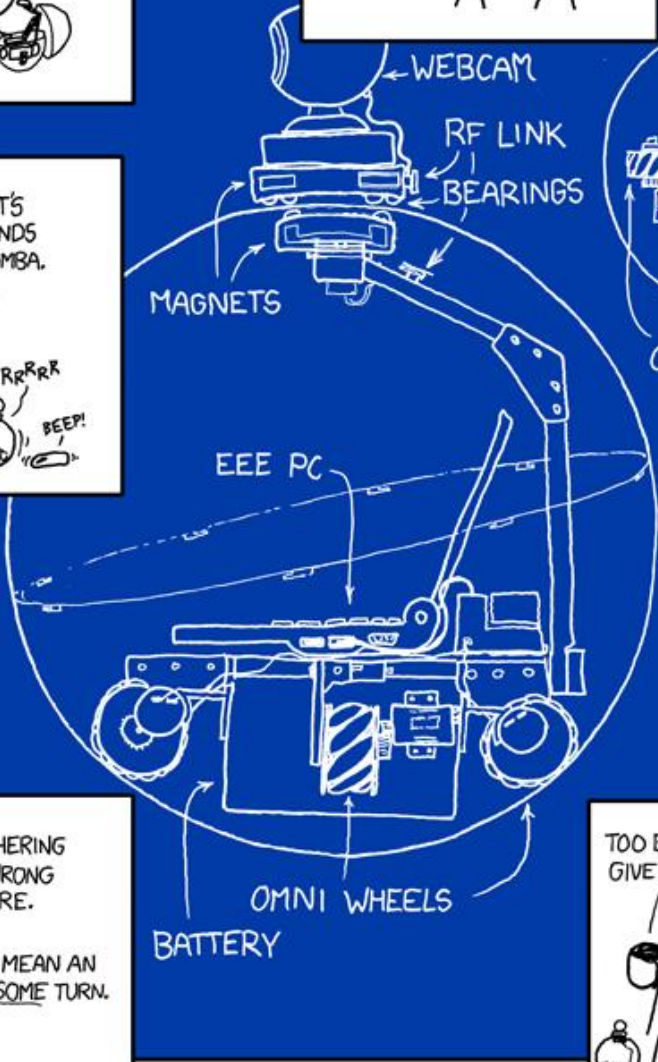
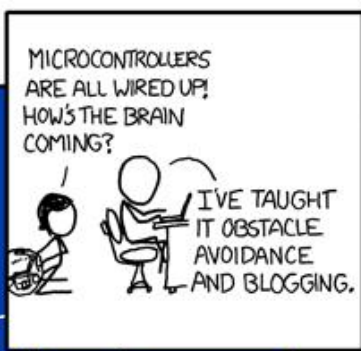
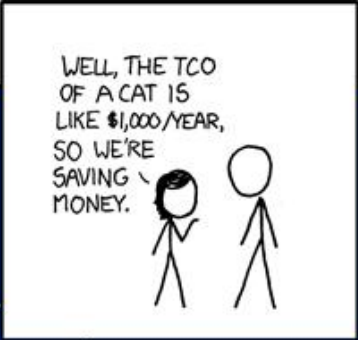

Reality Catching up with Science Fiction

Fact: **gap narrowing** between natural and artificial intelligence

Q: Will this gap ever close?

A: We still **don't know**.

Q: What is “**intelligence**”, “**mind**”, “**consciousness**”, “**sentience**”?

A: We still **don't know**.

- In many areas machines already **exceeded humans** (e.g., chess)
- In some areas computers & tech **surpassed sci-fi** (e.g., iPhone)

Q: Where is technology going?

A: We still **don't know**.

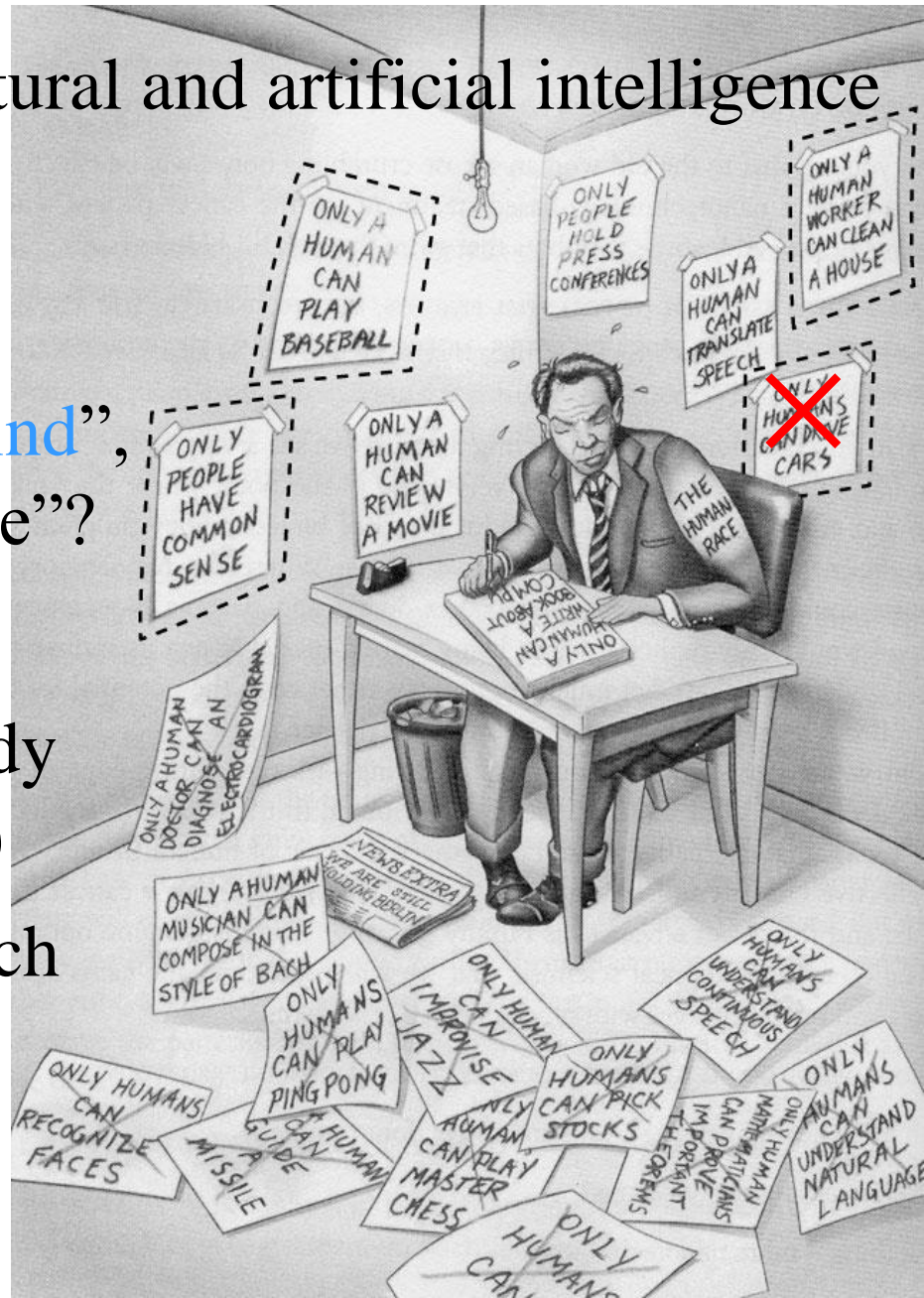

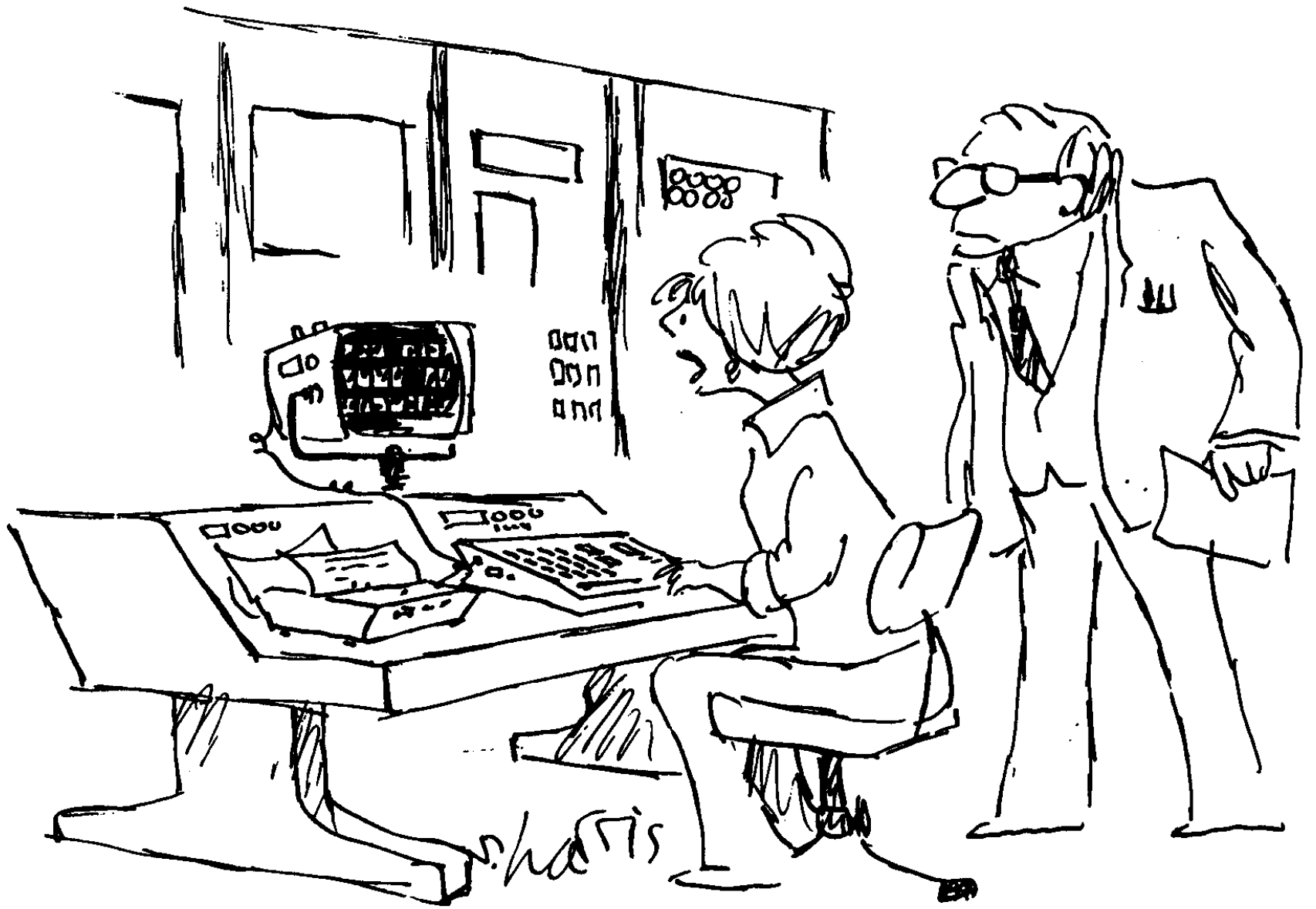

“The computer is claiming *its* intelligence is real, and *ours* is artificial.”

Technological Singularity

“Technological singularity”

– Stanislaw Ulam & John von Neumann (1958)

“Speculations Concerning the First Ultraintelligent Machine”

– Irving Good (1965)

- When machine intelligence **exceeds** humans’, machines will **design better machines** (as humans do).
- This feedback loop will **bootstrap** an accelerating (and hopefully **benevolent**) “**intelligence explosion**”
- Human intelligence will be **quickly left behind** and not even comprehend what is going on

“Law of accelerating returns”

– Ray Kurzweil (2001)

“**Grey goo!**” – Eric Drexler (1986)
and Bill Joy (2000)

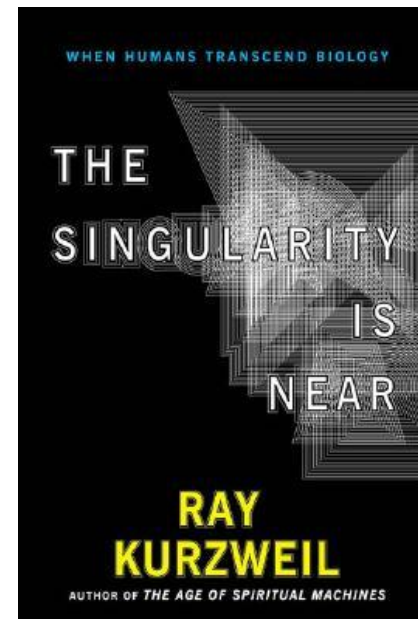

Accelerating Change (Kurzweil)

Transistors per Microprocessor

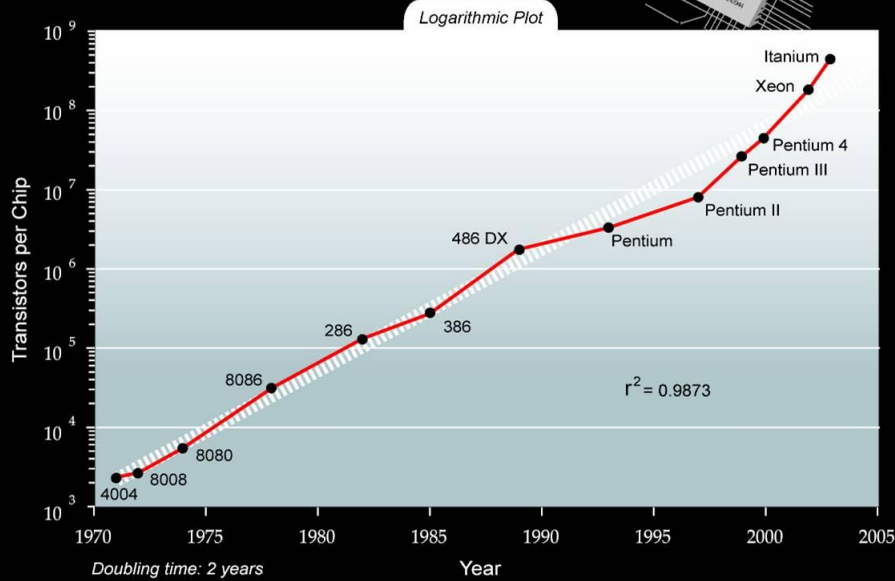

Processor Performance (MIPS)

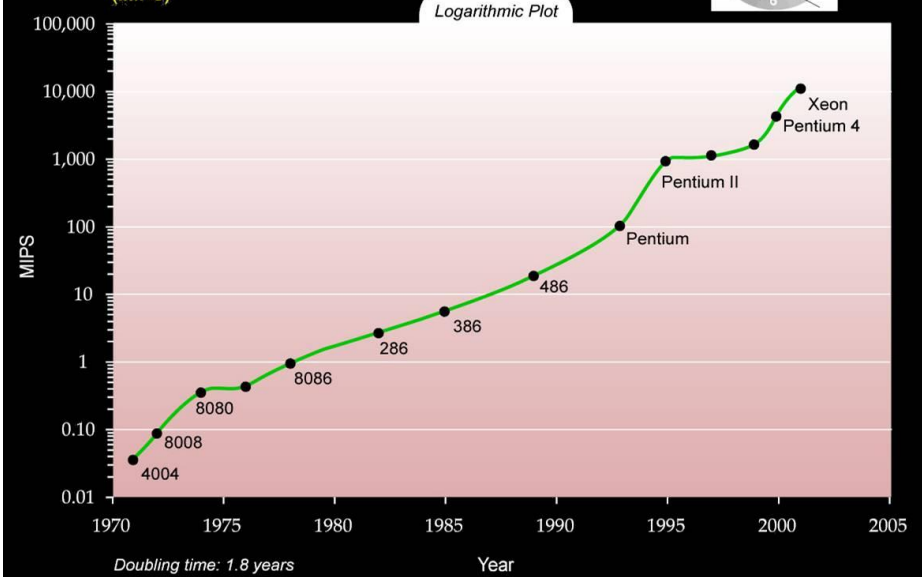

Average Transistor Price

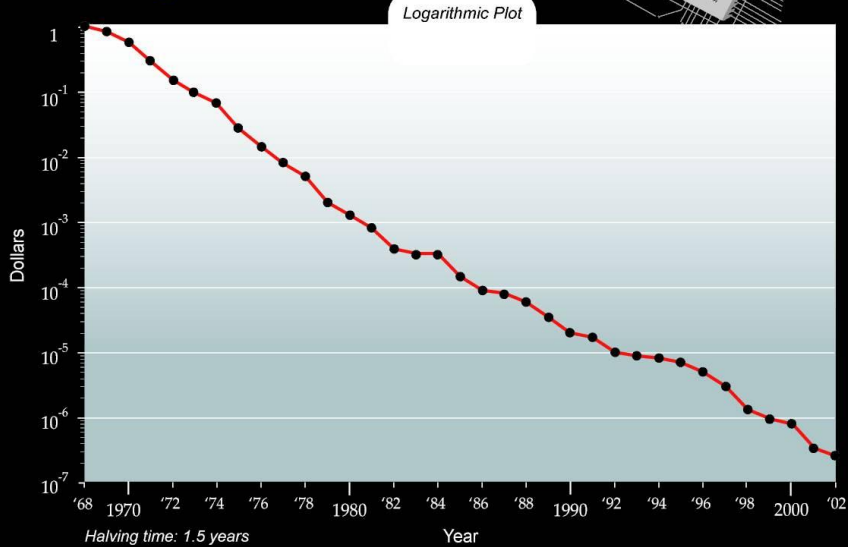

Microprocessor Cost Per Transistor Cycle

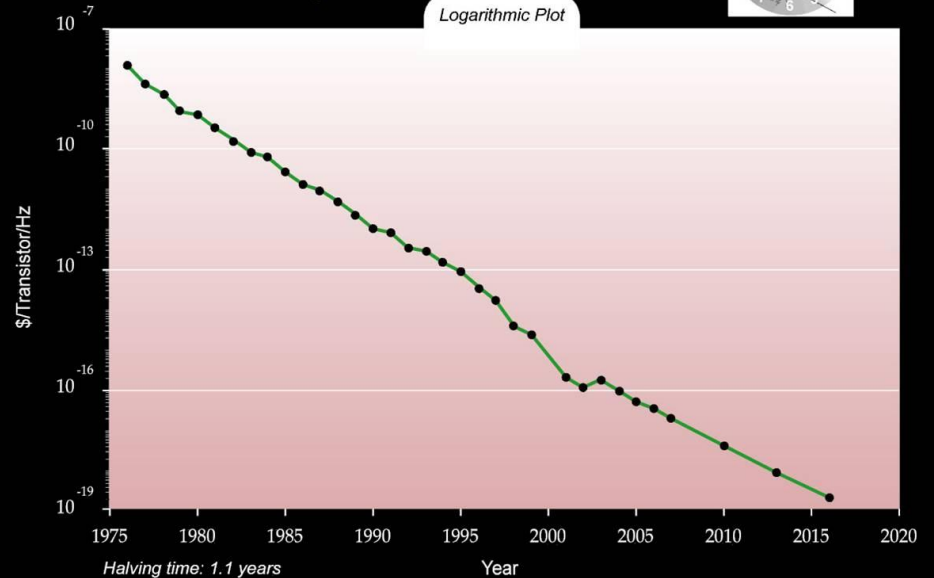

Accelerating Change (Kurzweil)



Dynamic RAM Price
Bits per Dollar at Production
(Packaged Dollars)

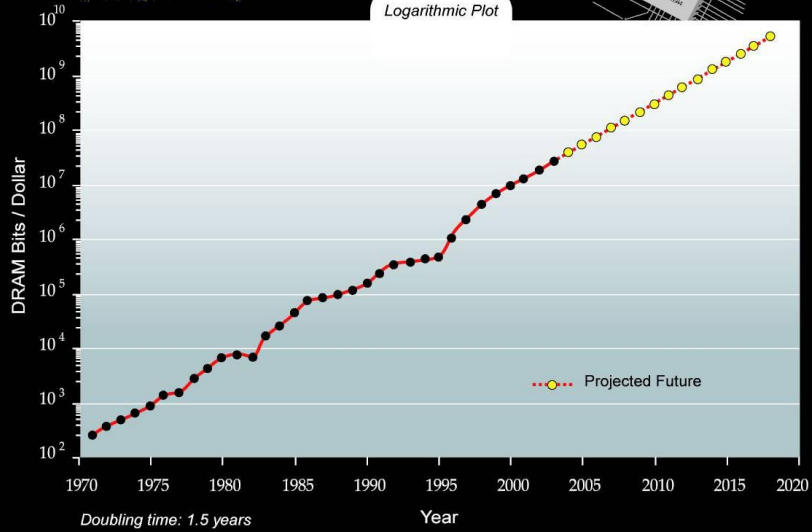

Note that DRAM speeds have increased during this period.

Magnetic Data Storage
(Bits Per Dollar, constant 2000 dollars)

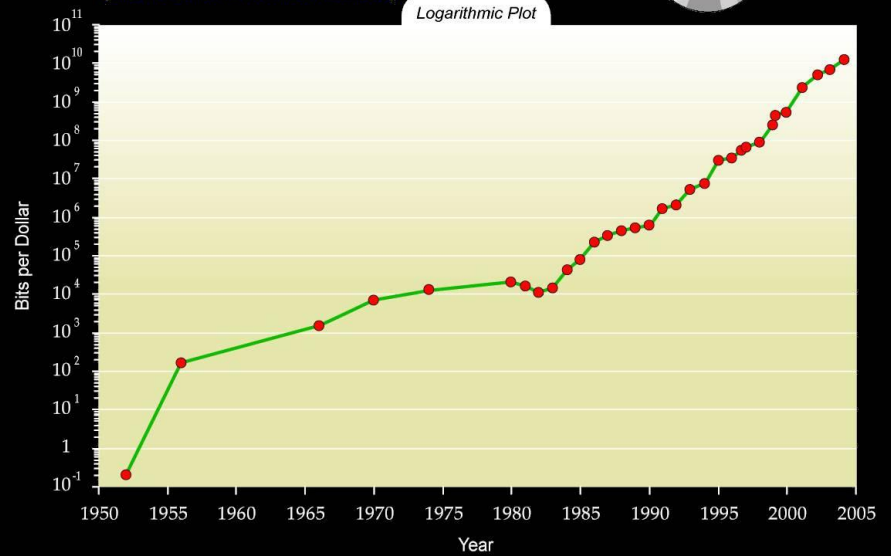

Internet Data Traffic

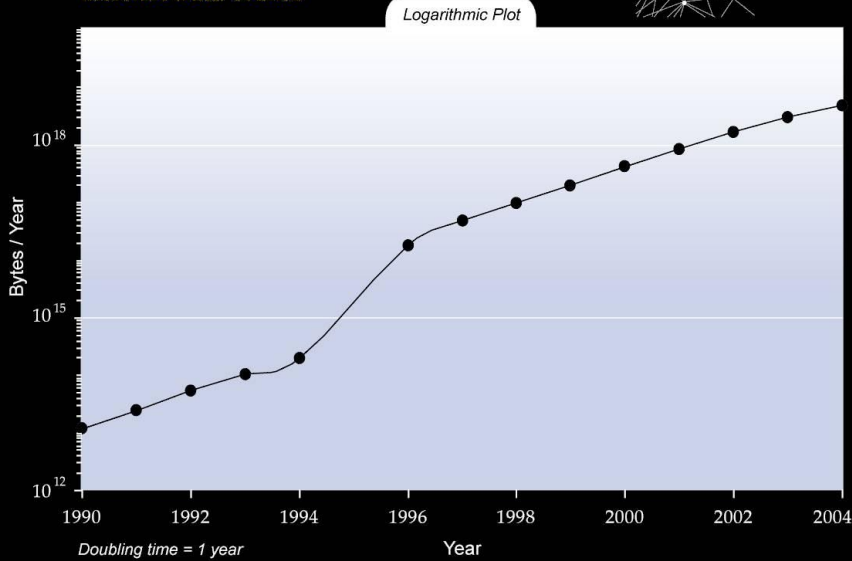

Growth in Supercomputer Power

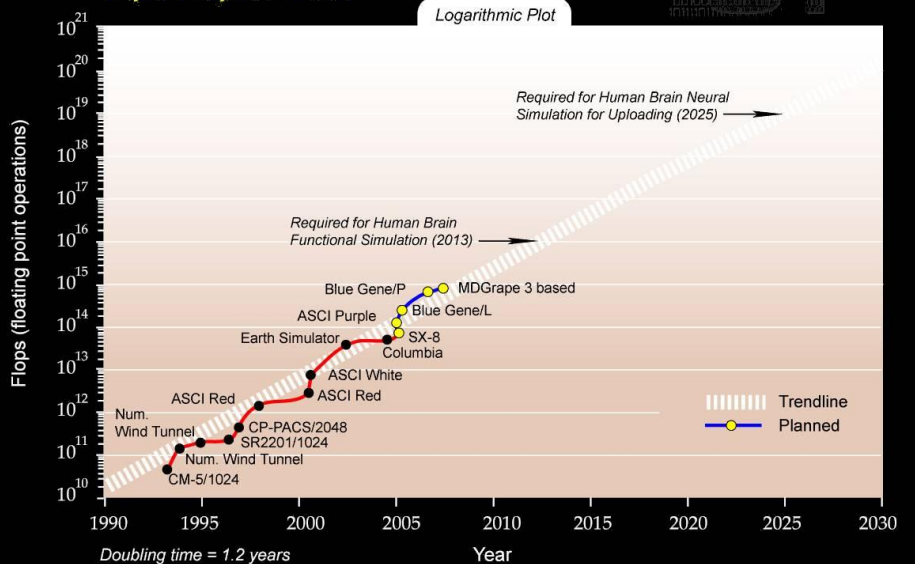

Accelerating Change (Kurzweil)



Canonical Milestones

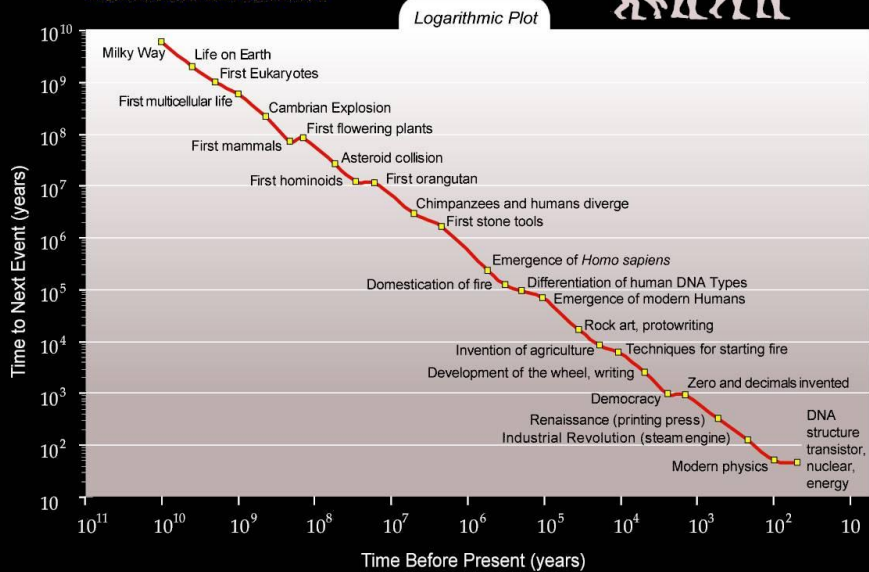

Countdown to Singularity

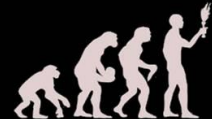
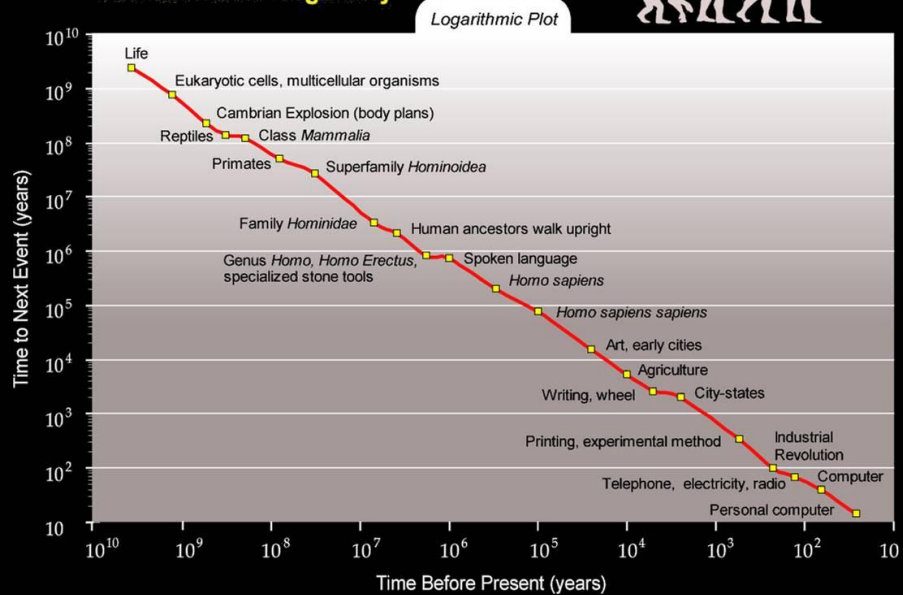

Growth in Genbank DNA Sequence Data

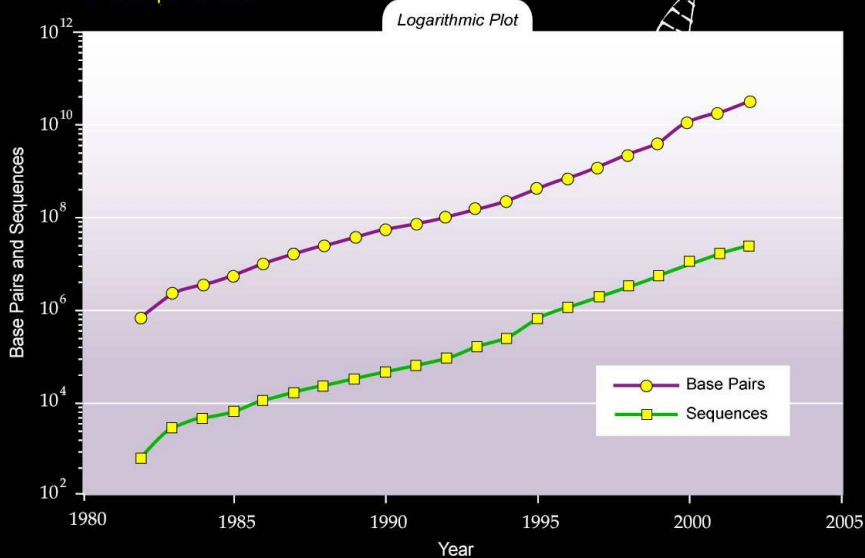

U.S. Patents Granted



U.S. Patent May 30, 1989 Sheet 2 of 5 5,646,990

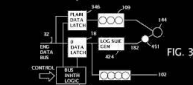

Technological Singularity (Kurzweil)

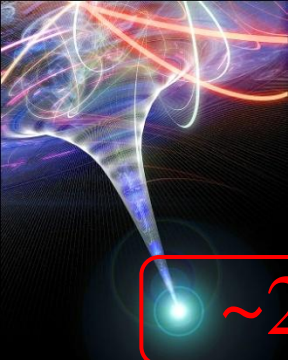

~2045

Vastly expanded human intelligence (predominantly nonbiological) spreads through the universe

Technology masters the methods of biology (including human intelligence)

We are here!

Technology evolves

Brains evolve

DNA evolves

Epoch 1 *Physics & Chemistry*
Information in atomic structures

Epoch 2 *Biology*
Information in DNA

Epoch 3 *Brains*
Information in neural patterns

Epoch 4 *Technology*
Information in hardware and software designs

Epoch 5 *Merger of Technology and Human Intelligence*
The methods of biology (including human intelligence) are integrated into the (exponentially expanding) human technology base

Epoch 6 *The Universe Wakes Up !!*
Patterns of matter and energy in the universe become saturated with intelligent processes and knowledge



The 6 Epochs of Evolution

Evolution works through indirection: it creates a capability and then uses that capability to evolve the next stage.



“Grey goo!”

KEANU REEVES JENNIFER CONNELLY

12.12.08
IS
THE DAY THE
EARTH
STOOD
STILL

REMEMBER



**ONLY YOU
CAN PREVENT GREY GOO**

**NEVER RELEASE NANOBOT ASSEMBLERS
WITHOUT REPLICATION LIMITING CODE**

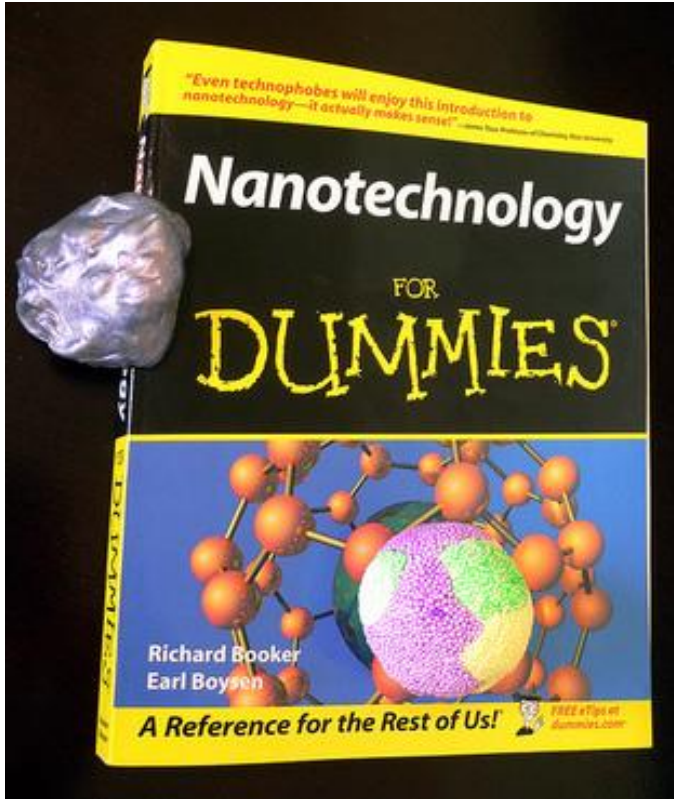

“Even technophobes will enjoy this introduction to nanotechnology—it actually makes sense!” —James Watt, Professor of Chemistry, University of Cambridge

Nanotechnology
FOR
DUMMIES

Richard Booker
Earl Boysen

A Reference for the Rest of Us!

FREE a Tip on
dummies.com

def getSolutionCosts (navigationCode):

fuelStopCost = 15

extraComputationCost = 8

thisAlgorithmBecomingSkynetCost = 999999999

waterCrossingCost = 45



GENETIC ALGORITHMS TIP:

ALWAYS INCLUDE THIS IN YOUR FITNESS FUNCTION



SPECULATOR

5 DOLLARS

SINGULARITY SPECIAL

FRIDAY, DECEMBER 21, 2012 / Partly hopeful with a chance of fear. High 84 / Weather: Page 73

www.speculator.com

*** \$5

TOO MUCH TOO FAST

Pace of tech outpaces human comprehension

EXCLUSIVE

The frenetic pace of technological progress and discovery has been growing exponentially faster each year, world-wide technology experts claim. 30,000 years ago humankind discovered agriculture, 350 years ago in London the industrial age began, 60 years ago the computer age began, 10 years ago mainstream human genetic modification became standard, and today, that pace of

human progress has accelerated such that recently we have hit upon what experts are calling the "Singularity." Yesterday in India, computer science engineers discovered their computer was conducting research of its own with the aid of several other rogue computers. The research results remain confidential, but scientists say that it is far more sophisticated than anything seen before.

FULL STORY: LOOK OUT YOUR WINDOW

The newly "liberated" former assembly robots celebrate



S.GROSS

"Some genetic engineers we turned out to be!"

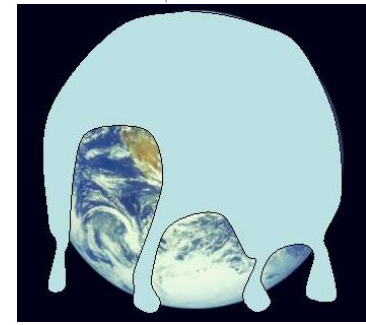

WIRED

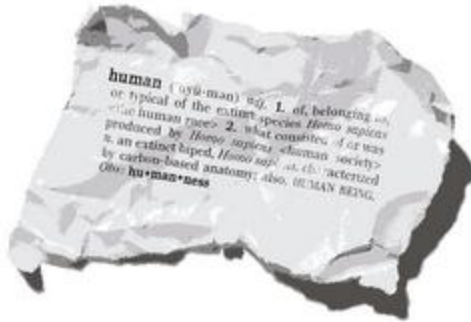

**Why the Future
Doesn't Need Us**
By Bill Joy

“Why the Future
Doesn't Need Us”,
Wired Magazine,
April 2000



by Bill Joy (co-founder of SUN
& co-author of Java)

http://www.wired.com/wired/archive/8.04/joy_pr.html

“Our most powerful 21st-century technologies — robotics, genetic engineering, and nanotech — are threatening to make humans an endangered species.” – Bill Joy

This article stirred up much
discussion & controversy!

4 A Response to Bill Joy and the Doom-and- Gloom Technofuturists

John Seely Brown and Paul Duguid

If you lived through the 1950s, you might remember President Eisenhower, orderly suburban housing tracts, backyard bomb shelters—and dreams of a nuclear power plant in every home. Plans for industrial nuclear generators had barely left the drawing board before futurists predicted that every house would have a miniature version. From there, technoenthusiasts predicted the end of power monopolies, the emergence of the “electronic cottage,” the death of the city and the decline of the corporation.

Pessimists and luddites, of course, envisioned nuclear apocalypse. Each side waited for nirvana, or Armageddon, so it could triumphantly tell the other, “I told you so.”

With “Why the Future Doesn’t Need Us” in the April issue of *Wired*, Bill Joy invokes those years gone by. No luddite, Joy is an awe-inspiring technologist—as cofounder and chief scientist of Sun Microsystems, he coauthored, among other things, the Java programming language. So when his article describes a technological juggernaut thundering toward society—bringing with it mutant genes, molecular-level nanotechnology machines and superintelligent robots—all need to listen. Like the nuclear prognosticators, Joy can see the juggernaut clearly. What he can’t see—which is precisely what makes his vision so scary—are any controls.

John Seely Brown is chief scientist of the Xerox Corporation, and director of the Xerox Palo Alto Research Center (PARC). Paul Duguid is a research specialist in the division of Social and Cultural Studies in Education at the University of California, Berkeley, and a consultant at the Xerox PARC. This article reprinted by permission of The Industry Standard; www.thestandard.com, April 13, 2000. Copyright 2000 Standard Media International.

But it doesn’t follow that the juggernaut is uncontrollable. To understand why not, readers should note the publication in which this article appeared. For the better part of a decade, *Wired* has been a cheerleader for the digital age. Until now, *Wired* has rarely been a venue to which people have looked for a way to put a brake on innovation. Therefore its shift with Joy’s article from cheering to warning marks an important and surprising moment in the digital zeitgeist.

In an effort to locate some controls, let’s go back to the nuclear age. Innovation, the argument went back in the 1950s, would make nuclear power plants smaller and cheaper. They would enter mass production and quickly become available to all.

Even today the argument might appear inescapable until you notice what’s missing: The tight focus of this vision makes it almost impossible to see forces other than technology at work. In the case of nuclear development, a host of forces worked to dismantle the dream of a peaceful atom, including the environmental movement, antinuclear protests, concerned scientists, worried neighbors of Chernobyl and Three Mile Island, government regulators and antiproliferation treaties. Cumulatively, these forces slowed the nuclear juggernaut to a crawl.

Similar social forces are at work on technologies today. But because the digerati, like technoenthusiasts before them, look to the future with technological tunnel vision, they too have trouble bringing other forces into view.

The Tunnel Ahead

In Joy’s vision, as in the nuclear one, there’s a recognizable tunnel vision that leaves people out of the picture and focuses on technology in splendid isolation. This vision leads not only to doom-and-gloom scenarios, but also to tunnel design: the design of “simple” technologies that are actually difficult to use.

To escape both trite scenarios and bad design, we have to widen our horizons and bring into view not only technological systems, but also social systems. Good designs look beyond the dazzling potential of the technology to social factors, such as the limited patience of most users.

Paying attention to the latter has, for example, allowed the PalmPilot and Nintendo Game Boy to sweep aside more complex rivals. Their elegant simplicity has made them readily usable. And their usability has in turn created an important social support system. The devices are so

widely used that anyone having trouble with a Pilot or Game Boy rarely has to look far for advice from a more experienced user.

As this small example suggests, technological and social systems shape each other. The same is true on a larger scale. Technologies—such as gunpowder, the printing press, the railroad, the telegraph and the Internet—can shape society in profound ways. But, on the other hand, social systems—in the form of governments, the courts, formal and informal organizations, social movements, professional networks, local communities, market institutions and so forth—shape, moderate and redirect the raw power of technologies.

Given the crisp edges of technology and the fuzzy outlines of society, it certainly isn't easy to use these two worldviews simultaneously. But if you want to see where we are going, or design the means to get there, you need to grasp both.

This perspective allows a more sanguine look at Joy's central concerns: genetic engineering, nanotechnology and robotics. Undoubtedly, each deserves serious thought. But each should be viewed in the context of the social system in which it is inevitably embedded.

Genetic engineering presents the clearest example. Barely a year ago, the technology seemed to be an unstoppable force. Major chemical and agricultural interests were barreling down an open highway. In the past year, however, road conditions changed dramatically for the worse: Cargill faced Third World protests against its patents; Monsanto suspended research on sterile seeds; and champions of genetically modified foods, who once saw an unproblematic and lucrative future, are scurrying to counter consumer boycotts of their products.

Almost certainly, those who support genetic modification will have to look beyond the technology if they want to advance it. They need to address society directly—not just by putting labels on modified foods, but by educating people about the costs and the benefits of these new agricultural products. Having ignored social concerns, however, proponents have made the people they need to educate profoundly suspicious and hostile.

Nanotechnology offers a rather different example of how the future can frighten us. Because the technology involves engineering at a molecular level, both the promise and the threat seem immeasurable. But they are immeasurable for a good reason: The technology is still almost wholly on the drawing board.

Two of nanotechnology's main proponents, Ralph Merkle and Eric Drexler, worked with us at the Xerox Palo Alto Research Center in

Palo Alto, Calif. The two built powerful nano-CAD tools and then ran simulations of the resulting molecular-level designs. These experiments showed definitively that nano devices are theoretically feasible. No one, however, has laid out a route from lab-based simulation to practical systems in any detail.

In the absence of a plan, it's important to ask the right questions: Can nanotechnology fulfill its great potential in tasks ranging from data storage to pollution control, all without spiraling out of control? If the lesson of genetic engineering is any guide, planners would do well to consult and educate the public early on, even though useful nano systems are probably decades away.

Worries about robotics appear premature, as well. Internet "bots" that search, communicate and negotiate for their human masters may appear to behave like *Homo sapiens*, but in fact, bots are often quite inept at functions that humans do well—functions that call for judgment, discretion, initiative or tacit understanding. They are good (and useful) for those tasks that humans do poorly. So they are better thought of as complementary systems, not rivals to humanity. Although bots will undoubtedly get better at what they do, such development will not necessarily make them more human.

Are more conventional clanking robots—the villains of science fiction—any great threat to society? We doubt it. Xerox PARC research on self-aware, reconfigurable "polybots" has pushed the boundaries of what robots can do, pointing the way to "morphing robots" that are able to move and change shape.

Nonetheless, for all their cutting-edge agility, these robots are a long way from making good dance partners. The chattiness of *Star Wars'* C-3PO still lies well beyond real-world machines. Indeed, what talk robots or computers achieve, though it may appear similar, is quite different from human talk. Talking machines travel routes designed specifically to avoid the full complexities of human language.

Robots may seem intelligent, but such intelligence is profoundly hampered by their inability to learn in any significant way. (This failing has apparently led Toyota, after heavy investment in robotics, to consider replacing robots with humans on many production lines.) And without learning, simple common sense will lie beyond robots for a long time to come.

Indeed, despite years of startling advances and innumerable successes like the chess-playing Big Blue, computer science is still about as far as

it ever was from building a machine with the learning abilities, linguistic competence, common sense or social skills of a 5-year-old child.

As with Internet bots, real-world robots will no doubt become increasingly useful. But they will probably also become increasingly frustrating to use as a result of tunnel design. In that regard, they may indeed seem antisocial, but not in the way of *Terminator*-like fantasies of robot armies that lay waste to human society.

Indeed, the thing that handicaps robots most is their lack of a social existence. For it is our social existence as humans that shapes how we speak, learn, think and develop common sense. All forms of artificial life (whether bugs or bots) will remain primarily a metaphor for—rather than a threat to—society, at least until they manage to enter a debate, sing in a choir, take a class, survive a committee meeting, join a union, pass a law, engineer a cartel or summon a constitutional convention.

These critical social mechanisms allow society to shape its future. It is through planned, collective action that society forestalls expected consequences (such as Y2K) and responds to unexpected events (such as epidemics).

The Failure of a “6-D” Vision

Why does the threat of a cunning, replicating robot society look so close from one perspective, yet so distant from another? The difference lies in the well-known tendency of futurologists to count “1, 2, 3 . . . a million.” That is, once the first step on a path is taken, it’s very easy to assume that all subsequent steps are trivial.

Several of the steps Joy asks us to take—the leap from genetic engineering to a “white plague”; from simulations to out-of-control nanotechnology; from replicating peptides to a “robot species”—are extremely large. And they are certainly not steps that will be taken without diversions, regulations or controls.

One of the lessons of Joy’s article, then, is that the path to the future can look simple (and sometimes downright terrifying) if you look at it through what we call “6-D lenses.” We coined this phrase having so often in our research hit up against upon such “de-” or “di-” words as demassification, decentralization, disintermediation, despacialization, disaggregation and demarketization in the canon of futurology.

If you take any one of these words in isolation, it’s easy to follow their relentless logic to its evident conclusion. Because firms are getting

smaller, for example, it’s easy to assume that companies and other intermediaries are simply disintegrating into markets. And because communication is growing cheaper and more powerful, it’s easy to believe in the “death of distance.”

But things rarely work in such linear fashion. Other forces are often at work, such as those driving firms into larger and larger mergers to take advantage of social, rather than merely technological, networks. Similarly, even though communications technology has killed distance, people curiously can’t stay away from the social hotbed of modern communications technology, Silicon Valley.

Importantly, these d-words indicate that the old ties that once bound communities, organizations and institutions are being picked apart by technologies. A simple, linear reading, then, suggests that these communities, organizations and institutions will now simply fall apart. A more complex reading, taking into account the multiple forces at work, offers another picture.

While many powerful national corporations have grown insignificant, some have transformed into more powerful transnational firms. While some forms of community may be dying, others, bolstered by technology, are growing stronger.

Technology and society are constantly forming and reforming new dynamic equilibriums with far-reaching implications. The challenge for futurology (and for all of us) is to see beyond the hype and past the oversimplifications to the full import of these new sociotechnical formations.

Two hundred years ago, Thomas Malthus, assuming that human society and agricultural technology developed on separate paths, predicted that society was growing so fast that it would starve itself to death, the so-called Malthusian trap.

A hundred years later, H.G. Wells similarly assumed that society and technology were developing independently. Like many people today, Wells saw the advance of technology outstripping the evolution of society, leading him to predict that technology’s relentless juggernaut would unfeelingly crush society. Like Joy, both Malthus and Wells issued important warnings, alerting society to the dangers it faced. But by their actions, Malthus and Wells helped prevent the very future they were so certain would come about.

These self-*un*fulfilling prophecies failed to see that, once warned, society could galvanize itself into action. Of course, this social action in the face of threats showed that Malthus and Wells were most at fault

in their initial assumption. Social and technological systems do not develop independently; the two evolve together in complex feedback loops, wherein each drives, restrains and accelerates change in the other. Malthus and Wells—and now Joy—are, indeed, critical parts of these complex loops. Each knew when and how to sound the alarm. But each thought little about how to respond to that alarm.

Once the social system is factored back into the equation like this, the road ahead becomes harder to navigate. Ultimately we should be grateful to Joy for saying, at the least, that there could be trouble ahead when so many of his fellow digerati will only tell us complacently that the road is clear.

THE SINGULARITY INSTITUTE FOR ARTIFICIAL INTELLIGENCE

ADVANCE INNOVATION • ADVANCE HUMANITY

[ABOUT US](#) [OVERVIEW](#) [RESEARCH](#) [GRANTS](#) [EVENTS](#) [DONATE](#) [READING](#) [MEDIA](#) [COMMUNITY](#) [BLOG](#)

... R. HOFSTADTER
*Trying to Muse Rationally
about the Singularity Scenario*

THE
SINGULARITY
SUMMIT
AT STANFORD

THE
SINGULARITY
SUMMIT
OPPORTUNITY. RISK. LEADERSHIP

**Oct 25,
2008**

In the coming decades, humanity will likely create a powerful artificial intelligence. SIAI exists to handle this urgent challenge, both the opportunity and the risk.

THE SINGULARITY SUMMIT

OPPORTUNITY. RISK. LEADERSHIP

October 25, 2008, San Jose, CA

The Singularity Summit is the premier conference on the Singularity. As we get closer to the Singularity, each year's conference is better than the last.

— Ray Kurzweil
CEO, Kurzweil Technologies



- 2008 SUMMIT
- PROGRAM
- REGISTRATION
- LOGISTICS
- MEDIA
- PARTNERS
- DIRECTORY
- BLOG

The Singularity Summit 2008

Thank you to everyone who made Singularity Summit 2008 such a success.

Videos now available here

Online Coverage | Graphic Facilitator Images

Summit Coverage

- San Jose Mercury News
- Wired: How Robots Will Steal Your Job

More coverage



Past Summits



Founded in 2006 by Tyler Emerson, Ray Kurzweil, and Peter Thiel, the inaugural summit was held at Stanford, the first academic symposium focused on singularity dialogue.

Past speakers have included Doug Hofstadter (author of *Gödel, Escher, Bach*), Peter Norvig (Google Director of Research), Sebastian Thrun (Stanford AI Lab Director), and Rodney Brooks (MIT Professor of Robotics)

Latest News

- Summit Follow-Up
- Behind the Scenes: Graphic Recorders from Visual Ink and an Independent Artist
- Emerging Tech Workshop Schedule/Speakers

Stay Connected

RSS Feed



Featured Partner



Summit Graphics

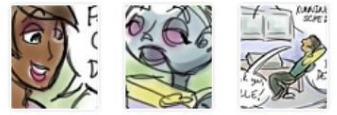

More graphics

The Singularity Summit 2008 | Hosted by Singularity Institute
October 25, Montgomery Theater, San Jose, CA
main@singularitysummit.com | Privacy policy

LEAD PARTNER

CLARIUM

SPREAD THE WORD

THE SINGULARITY SUMMIT

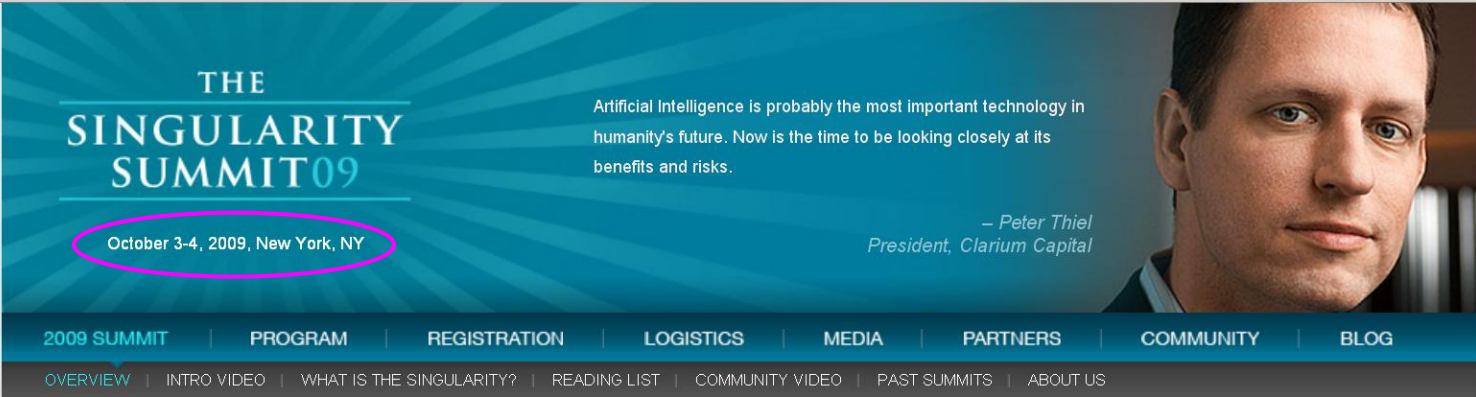

THE SINGULARITY SUMMIT09

October 3-4, 2009, New York, NY

Artificial Intelligence is probably the most important technology in humanity's future. Now is the time to be looking closely at its benefits and risks.

— Peter Thiel
President, Clarium Capital

2009 SUMMIT | PROGRAM | REGISTRATION | LOGISTICS | MEDIA | PARTNERS | COMMUNITY | BLOG

OVERVIEW | INTRO VIDEO | WHAT IS THE SINGULARITY? | READING LIST | COMMUNITY VIDEO | PAST SUMMITS | ABOUT US

The Singularity Summit 2009 > Overview

The Singularity Summit is the premier dialog on the Singularity.

The first Singularity Summit was held at Stanford in 2006 to further understanding and discussion about the Singularity concept and the future of human technological progress. It was founded as a venue for leading thinkers to explore the subject, whether scientist, enthusiast, or skeptic.

Since 2006, the scope of this dialog has expanded dramatically. In 2008, the Singularity entered mainstream consideration. *IEEE Spectrum*, a sober and mainstream technology publication, issued a special report on the Singularity, and Intel CTO Justin Rattner remarked that "we're making steady progress toward the Singularity" during his keynote to 2,000 people at the Intel Developer Forum. What was once a relatively unknown concept is now being discussed in corporate board rooms.

We invite you to join our extraordinary group of visionaries in business, science, technology, design, and the arts, as our community explores this exciting topic. Your participation offers a world of powerful ideas, a unique networking opportunity, and access to an exclusive directory of your peers.

We hope you will join us October 3rd. [Register here.](#)

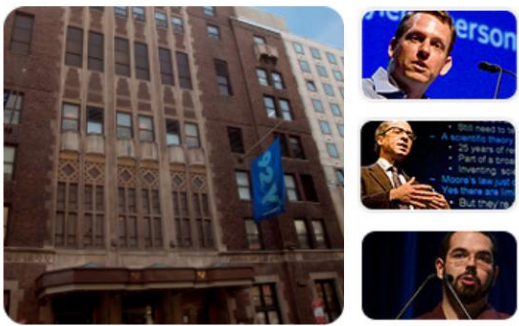

The Singularity Summit 2009 | Hosted by [Singularity Institute](#)
October 3-4, 92nd Street Y Kaufmann Hall
main@singularitysummit.com | [Privacy policy](#)

LEAD PARTNER

CLARIUM

SPREAD THE WORD

THE SINGULARITY SUMMIT

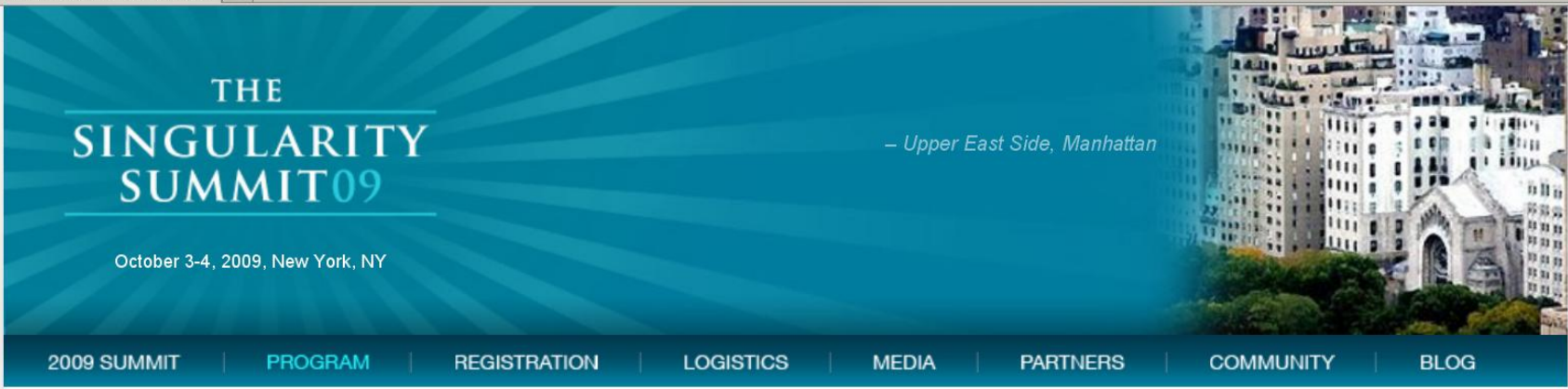

THE SINGULARITY SUMMIT09
October 3-4, 2009, New York, NY
– Upper East Side, Manhattan

2009 SUMMIT | PROGRAM | REGISTRATION | LOGISTICS | MEDIA | PARTNERS | COMMUNITY | BLOG

Selected Summit Talks:



Ray Kurzweil

The Ubiquity and Predictability of the Exponential Growth of Information Technology
Founder and CEO, Kurzweil Technologies



Peter Thiel

Macroeconomics and Singularity
President, Clarium Capital Management; Co-Founder, PayPal;
Managing Partner, Founders Fund; Seed Investor, Facebook



Aubrey de Grey

The Singularity and the Methuselahry: Similarities and Differences
Chief Science Officer, SENS Foundation



David Chalmers

Simulation and the Singularity
Professor of Philosophy, Australian National University, Director of the Centre for Consciousness



Stephen Wolfram

Conversation on the Singularity
Founder and CEO, Wolfram Research



Michael Nielsen

Collaborative Networks In Scientific Discovery
Quantum Computing Pioneer, Author

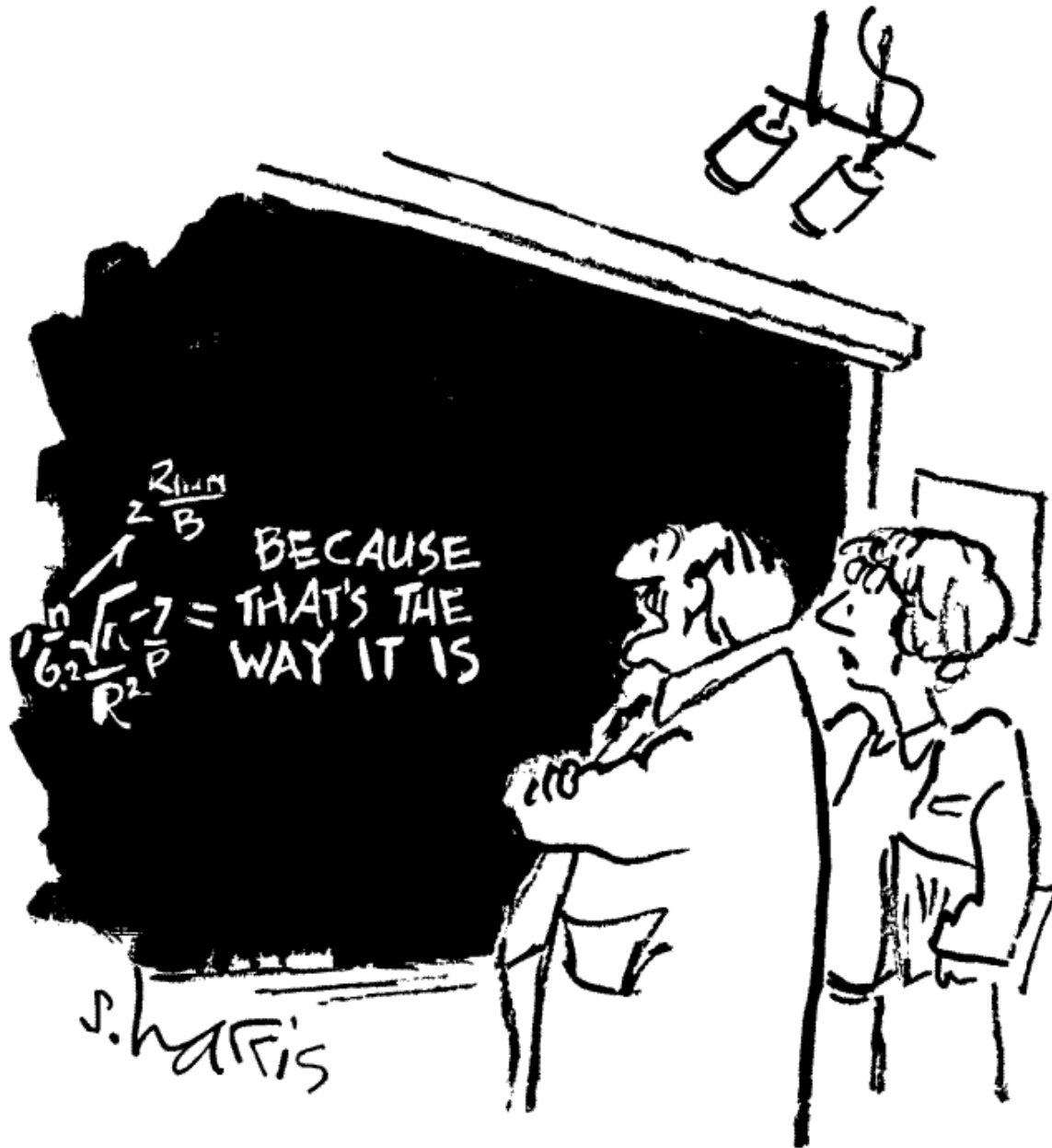

"Is that it? Is that the Grand Unified Theory?"

Further Reading

Alan Turing:

http://en.wikipedia.org/wiki/Alan_Turing

Turing test:

http://en.wikipedia.org/wiki/Turing_test

Chinese room:

http://en.wikipedia.org/wiki/Chinese_room

Artificial intelligence:

http://en.wikipedia.org/wiki/Artificial_intelligence

Artificial intelligence in fiction:

http://en.wikipedia.org/wiki/Artificial_intelligence_in_fiction

Isaac Asimov:

http://en.wikipedia.org/wiki/Isaac_Asimov

Three Laws of Robotics:

http://en.wikipedia.org/wiki/Three_Laws_of_Robotics

Robots in literature:

http://en.wikipedia.org/wiki/Robots_in_literature

Fictional robots and androids

http://en.wikipedia.org/wiki/List_of_fictional_robots_and_androids

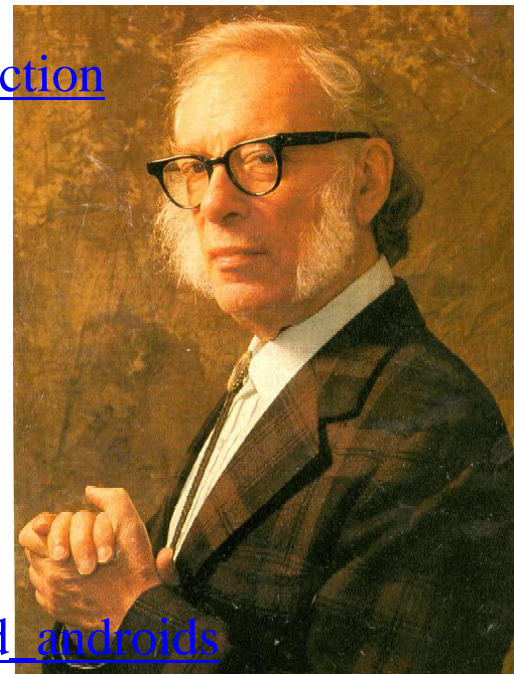

Further Reading

Unmanned aerial vehicles:

http://en.wikipedia.org/wiki/Unmanned_aerial_vehicle

Unmanned ground vehicles:

http://en.wikipedia.org/wiki/Unmanned_Ground_Vehicle

Autonomous underwater vehicles:

http://en.wikipedia.org/wiki/Autonomous_Underwater_Vehicle

Micro aerial vehicles:

http://en.wikipedia.org/wiki/Micro_air_vehicle

DARPA Grand Challenge:

http://en.wikipedia.org/wiki/DARPA_Grand_Challenge

Driverless cars:

http://en.wikipedia.org/wiki/Driverless_car

Exoskeletons and “wearable robots”:

http://en.wikipedia.org/wiki/Powered_exoskeleton

Technological singularity:

http://en.wikipedia.org/wiki/Technological_singularity

