

xv6

a simple, Unix-like teaching operating system

Russ Cox
Frans Kaashoek
Robert Morris

`xv6-book@pdos.csail.mit.edu`

Draft as of August 29, 2017

Contents

0	Operating system interfaces	7
1	Operating system organization	17
2	Page tables	29
3	Traps, interrupts, and drivers	39
4	Locking	51
5	Scheduling	61
6	File system	77
7	Summary	93
A	PC hardware	95
B	The boot loader	99
	Index	105

Foreword and acknowledgements

This is a draft text intended for a class on operating systems. It explains the main concepts of operating systems by studying an example kernel, named xv6. xv6 is a re-implementation of Dennis Ritchie's and Ken Thompson's Unix Version 6 (v6). xv6 loosely follows the structure and style of v6, but is implemented in ANSI C for an x86-based multiprocessor.

The text should be read along with the source code for xv6. This approach is inspired by John Lions's Commentary on UNIX 6th Edition (Peer to Peer Communications; ISBN: 1-57398-013-7; 1st edition (June 14, 2000)). See <https://pdos.csail.mit.edu/6.828> for pointers to on-line resources for v6 and xv6.

We have used this text in 6.828, the operating systems class at MIT. We thank the faculty, teaching assistants, and students of 6.828 who have all directly or indirectly contributed to xv6. In particular, we would like to thank Austin Clements and Nickolai Zeldovich. Finally, we would like to thank people who emailed us bugs in the text: Abutalib Aghayev, Sebastian Boehm, Anton Burtsev, Raphael Carvalho, Color Fuzzy, Giuseppe, Wolfgang Keller, Austin Liew, Pavan Maddamsetti, Jacek Masiulaniec, Askar Safin, Salman Shah, Pawel Szczurko, Warren Toomey, and Zou Chang Wei.

If you spot errors or have suggestions for improvement, please send email to Frans Kaashoek and Robert Morris (kaashoek,rtm@csail.mit.edu).

Chapter 0

Operating system interfaces

interface design
kernel
process
system call
user space
kernel space

The job of an operating system is to share a computer among multiple programs and to provide a more useful set of services than the hardware alone supports. The operating system manages and abstracts the low-level hardware, so that, for example, a word processor need not concern itself with which type of disk hardware is being used. It also shares the hardware among multiple programs so that they run (or appear to run) at the same time. Finally, operating systems provide controlled ways for programs to interact, so that they can share data or work together.

An operating system provides services to user programs through an interface. Designing a good interface turns out to be difficult. On the one hand, we would like the interface to be simple and narrow because that makes it easier to get the implementation right. On the other hand, we may be tempted to offer many sophisticated features to applications. The trick in resolving this tension is to design interfaces that rely on a few mechanisms that can be combined to provide much generality.

This book uses a single operating system as a concrete example to illustrate operating system concepts. That operating system, xv6, provides the basic interfaces introduced by Ken Thompson and Dennis Ritchie's Unix operating system, as well as mimicking Unix's internal design. Unix provides a narrow interface whose mechanisms combine well, offering a surprising degree of generality. This interface has been so successful that modern operating systems—BSD, Linux, Mac OS X, Solaris, and even, to a lesser extent, Microsoft Windows—have Unix-like interfaces. Understanding xv6 is a good start toward understanding any of these systems and many others.

As shown in Figure 0-1, xv6 takes the traditional form of a kernel, a special program that provides services to running programs. Each running program, called a process, has memory containing instructions, data, and a stack. The instructions implement the program's computation. The data are the variables on which the computation acts. The stack organizes the program's procedure calls.

When a process needs to invoke a kernel service, it invokes a procedure call in the operating system interface. Such a procedure is called a system call. The system call enters the kernel; the kernel performs the service and returns. Thus a process alternates between executing in user space and kernel space.

The kernel uses the CPU's hardware protection mechanisms to ensure that each process executing in user space can access only its own memory. The kernel executes with the hardware privileges required to implement these protections; user programs execute without those privileges. When a user program invokes a system call, the hardware raises the privilege level and starts executing a pre-arranged function in the kernel.

The collection of system calls that a kernel provides is the interface that user programs see. The xv6 kernel provides a subset of the services and system calls that Unix kernels traditionally offer. Figure 0-2 lists all of xv6's system calls.

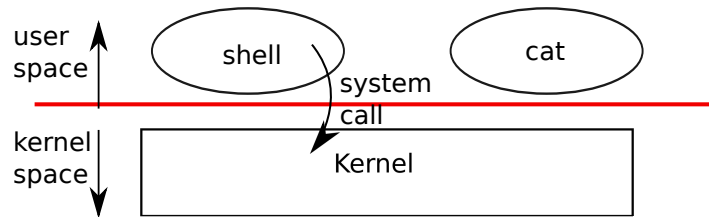

process

Figure 0-1. A kernel and two user processes.

The rest of this chapter outlines xv6’s services—processes, memory, file descriptors, pipes, and file system—and illustrates them with code snippets and discussions of how the shell, which is the primary user interface to traditional Unix-like systems, uses them. The shell’s use of system calls illustrates how carefully they have been designed.

shell
time-share
pid+code
fork+code
child process
parent process
fork+code
exit+code

The shell is an ordinary program that reads commands from the user and executes them. The fact that the shell is a user program, not part of the kernel, illustrates the power of the system call interface: there is nothing special about the shell. It also means that the shell is easy to replace; as a result, modern Unix systems have a variety of shells to choose from, each with its own user interface and scripting features. The xv6 shell is a simple implementation of the essence of the Unix Bourne shell. Its implementation can be found at line (8550).

Processes and memory

An xv6 process consists of user-space memory (instructions, data, and stack) and per-process state private to the kernel. Xv6 can time-share processes: it transparently switches the available CPUs among the set of processes waiting to execute. When a process is not executing, xv6 saves its CPU registers, restoring them when it next runs the process. The kernel associates a process identifier, or pid, with each process.

A process may create a new process using the fork system call. Fork creates a new process, called the child process, with exactly the same memory contents as the calling process, called the parent process. Fork returns in both the parent and the child. In the parent, fork returns the child’s pid; in the child, it returns zero. For example, consider the following program fragment:

```
int pid = fork();
if(pid > 0){
    printf("parent: child=%d\n", pid);
    pid = wait();
    printf("child %d is done\n", pid);
} else if(pid == 0){
    printf("child: exiting\n");
    exit();
} else {
    printf("fork error\n");
}
```

The exit system call causes the calling process to stop executing and to release re-

System call	Description
fork()	Create a process
exit()	Terminate the current process
wait()	Wait for a child process to exit
kill(pid)	Terminate process pid
getpid()	Return the current process's pid
sleep(n)	Sleep for n clock ticks
exec(filename, *argv)	Load a file and execute it
sbrk(n)	Grow process's memory by n bytes
open(filename, flags)	Open a file; the flags indicate read/write
read(fd, buf, n)	Read n bytes from an open file into buf
write(fd, buf, n)	Write n bytes to an open file
close(fd)	Release open file fd
dup(fd)	Duplicate fd
pipe(p)	Create a pipe and return fd's in p
chdir(dirname)	Change the current directory
mkdir(dirname)	Create a new directory
mknod(name, major, minor)	Create a device file
fstat(fd)	Return info about an open file
link(f1, f2)	Create another name (f2) for the file f1
unlink(filename)	Remove a file

Figure 0-2. Xv6 system calls

sources such as memory and open files. The `wait` system call returns the pid of an exited child of the current process; if none of the caller's children has exited, `wait` waits for one to do so. In the example, the output lines

```
parent: child=1234
child: exiting
```

might come out in either order, depending on whether the parent or child gets to its `printf` call first. After the child exits the parent's `wait` returns, causing the parent to print

```
parent: child 1234 is done
```

Although the child has the same memory contents as the parent initially, the parent and child are executing with different memory and different registers: changing a variable in one does not affect the other. For example, when the return value of `wait` is stored into `pid` in the parent process, it doesn't change the variable `pid` in the child. The value of `pid` in the child will still be zero.

The `exec` system call replaces the calling process's memory with a new memory image loaded from a file stored in the file system. The file must have a particular format, which specifies which part of the file holds instructions, which part is data, at which instruction to start, etc. xv6 uses the ELF format, which Chapter 2 discusses in more detail. When `exec` succeeds, it does not return to the calling program; instead, the instructions loaded from the file start executing at the entry point declared in the ELF header. `Exec` takes two arguments: the name of the file containing the executable and an array of string arguments. For example:

```
wait+code
wait+code
printf+code
wait+code
exec+code
exec+code
```

```

char *argv[3];

argv[0] = "echo";
argv[1] = "hello";
argv[2] = 0;
exec("/bin/echo", argv);
printf("exec error\n");

```

```

getcmd+code
fork+code
exec+code
fork+code
exec+code
malloc+code
sbrk+code
file descriptor

```

This fragment replaces the calling program with an instance of the program `/bin/echo` running with the argument list `echo hello`. Most programs ignore the first argument, which is conventionally the name of the program.

The xv6 shell uses the above calls to run programs on behalf of users. The main structure of the shell is simple; see `main` (8701). The main loop reads a line of input from the user with `getcmd`. Then it calls `fork`, which creates a copy of the shell process. The parent calls `wait`, while the child runs the command. For example, if the user had typed “echo hello” to the shell, `runcmd` would have been called with “echo hello” as the argument. `runcmd` (8606) runs the actual command. For “echo hello”, it would call `exec` (8626). If `exec` succeeds then the child will execute instructions from `echo` instead of `runcmd`. At some point `echo` will call `exit`, which will cause the parent to return from `wait` in `main` (8701). You might wonder why `fork` and `exec` are not combined in a single call; we will see later that separate calls for creating a process and loading a program is a clever design.

Xv6 allocates most user-space memory implicitly: `fork` allocates the memory required for the child’s copy of the parent’s memory, and `exec` allocates enough memory to hold the executable file. A process that needs more memory at run-time (perhaps for `malloc`) can call `sbrk(n)` to grow its data memory by `n` bytes; `sbrk` returns the location of the new memory.

Xv6 does not provide a notion of users or of protecting one user from another; in Unix terms, all xv6 processes run as root.

I/O and File descriptors

A file descriptor is a small integer representing a kernel-managed object that a process may read from or write to. A process may obtain a file descriptor by opening a file, directory, or device, or by creating a pipe, or by duplicating an existing descriptor. For simplicity we’ll often refer to the object a file descriptor refers to as a “file”; the file descriptor interface abstracts away the differences between files, pipes, and devices, making them all look like streams of bytes.

Internally, the xv6 kernel uses the file descriptor as an index into a per-process table, so that every process has a private space of file descriptors starting at zero. By convention, a process reads from file descriptor 0 (standard input), writes output to file descriptor 1 (standard output), and writes error messages to file descriptor 2 (standard error). As we will see, the shell exploits the convention to implement I/O redirection and pipelines. The shell ensures that it always has three file descriptors open (8707), which are by default file descriptors for the console.

The `read` and `write` system calls read bytes from and write bytes to open files named by file descriptors. The call `read(fd, buf, n)` reads at most `n` bytes from the

file descriptor `fd`, copies them into `buf`, and returns the number of bytes read. Each file descriptor that refers to a file has an offset associated with it. `read` reads data from the current file offset and then advances that offset by the number of bytes read: a subsequent read will return the bytes following the ones returned by the first read. When there are no more bytes to read, `read` returns zero to signal the end of the file.

fork+code
exec+code

The call `write(fd, buf, n)` writes `n` bytes from `buf` to the file descriptor `fd` and returns the number of bytes written. Fewer than `n` bytes are written only when an error occurs. Like `read`, `write` writes data at the current file offset and then advances that offset by the number of bytes written: each `write` picks up where the previous one left off.

The following program fragment (which forms the essence of `cat`) copies data from its standard input to its standard output. If an error occurs, it writes a message to the standard error.

```
char buf[512];
int n;

for(;;){
    n = read(0, buf, sizeof buf);
    if(n == 0)
        break;
    if(n < 0){
        fprintf(2, "read error\n");
        exit();
    }
    if(write(1, buf, n) != n){
        fprintf(2, "write error\n");
        exit();
    }
}
```

The important thing to note in the code fragment is that `cat` doesn't know whether it is reading from a file, console, or a pipe. Similarly `cat` doesn't know whether it is printing to a console, a file, or whatever. The use of file descriptors and the convention that file descriptor 0 is input and file descriptor 1 is output allows a simple implementation of `cat`.

The `close` system call releases a file descriptor, making it free for reuse by a future `open`, `pipe`, or `dup` system call (see below). A newly allocated file descriptor is always the lowest-numbered unused descriptor of the current process.

File descriptors and `fork` interact to make I/O redirection easy to implement. `Fork` copies the parent's file descriptor table along with its memory, so that the child starts with exactly the same open files as the parent. The system call `exec` replaces the calling process's memory but preserves its file table. This behavior allows the shell to implement I/O redirection by forking, reopening chosen file descriptors, and then executing the new program. Here is a simplified version of the code a shell runs for the command `cat < input.txt`:

```

char *argv[2];

argv[0] = "cat";
argv[1] = 0;
if(fork() == 0) {
    close(0);
    open("input.txt", O_RDONLY);
    exec("cat", argv);
}

```

After the child closes file descriptor 0, `open` is guaranteed to use that file descriptor for the newly opened `input.txt`: 0 will be the smallest available file descriptor. `Cat` then executes with file descriptor 0 (standard input) referring to `input.txt`.

The code for I/O redirection in the `xv6` shell works in exactly this way (8630). Recall that at this point in the code the shell has already forked the child shell and that `runcmd` will call `exec` to load the new program. Now it should be clear why it is a good idea that `fork` and `exec` are separate calls. Because if they are separate, the shell can fork a child, use `open`, `close`, `dup` in the child to change the standard input and output file descriptors, and then `exec`. No changes to the program being `exec`-ed (`cat` in our example) are required. If `fork` and `exec` were combined into a single system call, some other (probably more complex) scheme would be required for the shell to redirect standard input and output, or the program itself would have to understand how to redirect I/O.

Although `fork` copies the file descriptor table, each underlying file offset is shared between parent and child. Consider this example:

```

if(fork() == 0) {
    write(1, "hello ", 6);
    exit();
} else {
    wait();
    write(1, "world\n", 6);
}

```

At the end of this fragment, the file attached to file descriptor 1 will contain the data `hello world`. The `write` in the parent (which, thanks to `wait`, runs only after the child is done) picks up where the child's `write` left off. This behavior helps produce sequential output from sequences of shell commands, like (`echo hello; echo world`) `>output.txt`.

The `dup` system call duplicates an existing file descriptor, returning a new one that refers to the same underlying I/O object. Both file descriptors share an offset, just as the file descriptors duplicated by `fork` do. This is another way to write `hello world` into a file:

```

fd = dup(1);
write(1, "hello ", 6);
write(fd, "world\n", 6);

```

Two file descriptors share an offset if they were derived from the same original file descriptor by a sequence of `fork` and `dup` calls. Otherwise file descriptors do not share offsets, even if they resulted from `open` calls for the same file. `Dup` allows shells

to implement commands like this: `ls existing-file non-existing-file > tmp1 2>&1` ^{pipe}. The `2>&1` tells the shell to give the command a file descriptor 2 that is a duplicate of descriptor 1. Both the name of the existing file and the error message for the non-existing file will show up in the file `tmp1`. The `xv6` shell doesn't support I/O redirection for the error file descriptor, but now you know how to implement it.

File descriptors are a powerful abstraction, because they hide the details of what they are connected to: a process writing to file descriptor 1 may be writing to a file, to a device like the console, or to a pipe.

Pipes

A pipe is a small kernel buffer exposed to processes as a pair of file descriptors, one for reading and one for writing. Writing data to one end of the pipe makes that data available for reading from the other end of the pipe. Pipes provide a way for processes to communicate.

The following example code runs the program `wc` with standard input connected to the read end of a pipe.

```
int p[2];
char *argv[2];

argv[0] = "wc";
argv[1] = 0;

pipe(p);
if(fork() == 0) {
    close(0);
    dup(p[0]);
    close(p[0]);
    close(p[1]);
    exec("/bin/wc", argv);
} else {
    close(p[0]);
    write(p[1], "hello world\n", 12);
    close(p[1]);
}
```

The program calls `pipe`, which creates a new pipe and records the read and write file descriptors in the array `p`. After `fork`, both parent and child have file descriptors referring to the pipe. The child dups the read end onto file descriptor 0, closes the file descriptors in `p`, and execs `wc`. When `wc` reads from its standard input, it reads from the pipe. The parent closes the read side of the pipe, writes to the pipe, and then closes the write side.

If no data is available, a read on a pipe waits for either data to be written or all file descriptors referring to the write end to be closed; in the latter case, read will return 0, just as if the end of a data file had been reached. The fact that read blocks until it is impossible for new data to arrive is one reason that it's important for the child to close the write end of the pipe before executing `wc` above: if one of `wc`'s file descriptors referred to the write end of the pipe, `wc` would never see end-of-file.

The xv6 shell implements pipelines such as `grep fork sh.c | wc -l` in a manner similar to the above code (8650). The child process creates a pipe to connect the left end of the pipeline with the right end. Then it calls `fork` and `runcmd` for the left end of the pipeline and `fork` and `runcmd` for the right end, and waits for both to finish. The right end of the pipeline may be a command that itself includes a pipe (e.g., `a | b | c`), which itself forks two new child processes (one for `b` and one for `c`). Thus, the shell may create a tree of processes. The leaves of this tree are commands and the interior nodes are processes that wait until the left and right children complete. In principle, you could have the interior nodes run the left end of a pipeline, but doing so correctly would complicate the implementation.

root
path
current directory

Pipes may seem no more powerful than temporary files: the pipeline

```
echo hello world | wc
```

could be implemented without pipes as

```
echo hello world >/tmp/xyz; wc </tmp/xyz
```

Pipes have at least four advantages over temporary files in this situation. First, pipes automatically clean themselves up; with the file redirection, a shell would have to be careful to remove `/tmp/xyz` when done. Second, pipes can pass arbitrarily long streams of data, while file redirection requires enough free space on disk to store all the data. Third, pipes allow for parallel execution of pipeline stages, while the file approach requires the first program to finish before the second starts. Fourth, if you are implementing inter-process communication, pipes' blocking reads and writes are more efficient than the non-blocking semantics of files.

File system

The xv6 file system provides data files, which are uninterpreted byte arrays, and directories, which contain named references to data files and other directories. The directories form a tree, starting at a special directory called the root. A path like `/a/b/c` refers to the file or directory named `c` inside the directory named `b` inside the directory named `a` in the root directory `/`. Paths that don't begin with `/` are evaluated relative to the calling process's current directory, which can be changed with the `chdir` system call. Both these code fragments open the same file (assuming all the directories involved exist):

```
chdir("/a");  
chdir("b");  
open("c", O_RDONLY);  
  
open("/a/b/c", O_RDONLY);
```

The first fragment changes the process's current directory to `/a/b`; the second neither refers to nor changes the process's current directory.

There are multiple system calls to create a new file or directory: `mkdir` creates a new directory, `open` with the `O_CREATE` flag creates a new data file, and `mknod` creates a new device file. This example illustrates all three:

```
mkdir("/dir");  
fd = open("/dir/file", O_CREATE|O_WRONLY);  
close(fd);  
mknod("/console", 1, 1);
```

Mknod creates a file in the file system, but the file has no contents. Instead, the file's metadata marks it as a device file and records the major and minor device numbers (the two arguments to `mknod`), which uniquely identify a kernel device. When a process later opens the file, the kernel diverts read and write system calls to the kernel device implementation instead of passing them to the file system.

`fstat` retrieves information about the object a file descriptor refers to. It fills in a `struct stat`, defined in `stat.h` as:

```
#define T_DIR 1 // Directory  
#define T_FILE 2 // File  
#define T_DEV 3 // Device  
  
struct stat {  
    short type; // Type of file  
    int dev; // File system's disk device  
    uint ino; // Inode number  
    short nlink; // Number of links to file  
    uint size; // Size of file in bytes  
};
```

A file's name is distinct from the file itself; the same underlying file, called an *inode*, can have multiple names, called *links*. The `link` system call creates another file system name referring to the same inode as an existing file. This fragment creates a new file named both `a` and `b`.

```
open("a", O_CREATE|O_WRONLY);  
link("a", "b");
```

Reading from or writing to `a` is the same as reading from or writing to `b`. Each inode is identified by a unique *inode number*. After the code sequence above, it is possible to determine that `a` and `b` refer to the same underlying contents by inspecting the result of `fstat`: both will return the same inode number (`ino`), and the `nlink` count will be set to 2.

The `unlink` system call removes a name from the file system. The file's inode and the disk space holding its content are only freed when the file's link count is zero and no file descriptors refer to it. Thus adding

```
unlink("a");
```

to the last code sequence leaves the inode and file content accessible as `b`. Furthermore,

```
fd = open("/tmp/xyz", O_CREATE|O_RDWR);  
unlink("/tmp/xyz");
```

is an idiomatic way to create a temporary inode that will be cleaned up when the process closes `fd` or exits.

Shell commands for file system operations are implemented as user-level programs such as `mkdir`, `ln`, `rm`, etc. This design allows anyone to extend the shell with

new user commands by just adding a new user-level program. In hindsight this plan seems obvious, but other systems designed at the time of Unix often built such commands into the shell (and built the shell into the kernel).

One exception is `cd`, which is built into the shell (8716). `cd` must change the current working directory of the shell itself. If `cd` were run as a regular command, then the shell would fork a child process, the child process would run `cd`, and `cd` would change the *child's* working directory. The parent's (i.e., the shell's) working directory would not change.

Real world

Unix's combination of the “standard” file descriptors, pipes, and convenient shell syntax for operations on them was a major advance in writing general-purpose reusable programs. The idea sparked a whole culture of “software tools” that was responsible for much of Unix's power and popularity, and the shell was the first so-called “scripting language.” The Unix system call interface persists today in systems like BSD, Linux, and Mac OS X.

The Unix system call interface has been standardized through the Portable Operating System Interface (POSIX) standard. Xv6 is *not* POSIX compliant. It misses system calls (including basic ones such as `lseek`), it implements systems calls only partially, etc. Our main goals for xv6 are simplicity and clarity while providing a simple UNIX-like system-call interface. Several people have extended xv6 with a few more basic system calls and a simple C library so that they can run basic Unix programs. Modern kernels, however, provide many more system calls, and many more kinds of kernel services, than xv6. For example, they support networking, Window systems, user-level threads, drivers for many devices, and so on. Modern kernels evolve continuously and rapidly, and offer many features beyond POSIX.

For the most part, modern Unix-derived operating systems have not followed the early Unix model of exposing devices as special files, like the `console` device file discussed above. The authors of Unix went on to build Plan 9, which applied the “resources are files” concept to modern facilities, representing networks, graphics, and other resources as files or file trees.

The file system abstraction has been a powerful idea, most recently applied to network resources in the form of the World Wide Web. Even so, there are other models for operating system interfaces. Multics, a predecessor of Unix, abstracted file storage in a way that made it look like memory, producing a very different flavor of interface. The complexity of the Multics design had a direct influence on the designers of Unix, who tried to build something simpler.

This book examines how xv6 implements its Unix-like interface, but the ideas and concepts apply to more than just Unix. Any operating system must multiplex processes onto the underlying hardware, isolate processes from each other, and provide mechanisms for controlled inter-process communication. After studying xv6, you should be able to look at other, more complex operating systems and see the concepts underlying xv6 in those systems as well.

Chapter 1

time-share
isolation
monolithic kernel

Operating system organization

A key requirement for an operating system is to support several activities at once. For example, using the system call interface described in chapter 0 a process can start new processes with `fork`. The operating system must `time-share` the resources of the computer among these processes. For example, even if there are more processes than there are hardware processors, the operating system must ensure that all of the processes make progress. The operating system must also arrange for `isolation` between the processes. That is, if one process has a bug and fails, it shouldn't affect processes that don't depend on the failed process. Complete isolation, however, is too strong, since it should be possible for processes to interact; pipelines are an example. Thus an operating system must fulfil three requirements: multiplexing, isolation, and interaction.

This chapter provides an overview of how operating systems are organized to achieve these 3 requirements. It turns out there are many ways to do so, but this text focuses on mainstream designs centered around a `monolithic kernel`, which is used by many Unix operating systems. This chapter introduces `xv6`'s design by tracing the creation of the first process when `xv6` starts running. In doing so, the text provides a glimpse of the implementation of all major abstractions that `xv6` provides, how they interact, and how the three requirements of multiplexing, isolation, and interaction are met. Most of `xv6` avoids special-casing the first process, and instead reuses code that `xv6` must provide for standard operation. Subsequent chapters will explore each abstraction in more detail.

`Xv6` runs on Intel 80386 or later (“x86”) processors on a PC platform, and much of its low-level functionality (for example, its process implementation) is x86-specific. This book assumes the reader has done a bit of machine-level programming on some architecture, and will introduce x86-specific ideas as they come up. Appendix A briefly outlines the PC platform.

Abstracting physical resources

The first question one might ask when encountering an operating system is why have it at all? That is, one could implement the system calls in Figure 0-2 as a library, with which applications link. In this plan, each application could even have its own library tailored to its needs. Applications could directly interact with hardware resources and use those resources in the best way for the application (e.g., to achieve high or predictable performance). Some operating systems for embedded devices or real-time systems are organized in this way.

The downside of this library approach is that, if there is more than one applica-

tion running, the applications must be well-behaved. For example, each application must periodically give up the processor so that other applications can run. Such a *co-operative* time-sharing scheme may be OK if all applications trust each other and have no bugs. It's more typical for applications to not trust each other, and to have bugs, so one often wants stronger isolation than a cooperative scheme provides.

kernel mode
user mode
privileged
instructions

To achieve strong isolation it's helpful to forbid applications from directly accessing sensitive hardware resources, and instead to abstract the resources into services. For example, applications interact with a file system only through `open`, `read`, `write`, and `close` system calls, instead of reading and writing raw disk sectors. This provides the application with the convenience of pathnames, and it allows the operating system (as the implementor of the interface) to manage the disk.

Similarly, Unix transparently switches hardware processors among processes, saving and restoring register state as necessary, so that applications don't have to be aware of time sharing. This transparency allows the operating system to share processors even if some applications are in infinite loops.

As another example, Unix processes use `exec` to build up their memory image, instead of directly interacting with physical memory. This allows the operating system to decide where to place a process in memory; if memory is tight, the operating system might even store some of a process's data on disk. `Exec` also provides users with the convenience of a file system to store executable program images.

Many forms of interaction among Unix processes occur via file descriptors. Not only do file descriptors abstract away many details (e.g. where data in a pipe or file is stored), they also are defined in a way that simplifies interaction. For example, if one application in a pipeline fails, the kernel generates end-of-file for the next process in the pipeline.

As you can see, the system call interface in Figure 0-2 is carefully designed to provide both programmer convenience and the possibility of strong isolation. The Unix interface is not the only way to abstract resources, but it has proven to be a very good one.

User mode, kernel mode, and system calls

Strong isolation requires a hard boundary between applications and the operating system. If the application makes a mistake, we don't want the operating system to fail. Instead, the operating system should be able to clean up the failed application and continue running other applications. Applications shouldn't be able to modify (or even read) the operating system's data structures or instructions, should be able to access other process's memory, etc.

Processors provide hardware support for strong isolation. For example, the x86 processor, like many other processors, has two modes in which the processor can execute instructions: `kernel mode` and `user mode`. In `kernel mode` the processor is allowed to execute `privileged instructions`. For example, reading and writing the disk (or any other I/O device) involves `privileged instructions`. If an application in `user mode` attempts to execute a `privileged instruction`, then the processor doesn't exe-

cute the instruction, but switches to kernel mode so that the software in kernel mode can clean up the application, because it did something it shouldn't be doing. Figure 0-1 in Chapter 0 illustrates this organization. An application can execute only user-mode instructions (e.g., adding numbers, etc.) and is said to be running in `user space`, while the software in kernel mode can also execute privileged instructions and is said to be running in `kernel space`. The software running in kernel space (or in kernel mode) is called the `kernel`.

`user space`
`kernel space`
`kernel`
`monolithic kernel`
`microkernel`

An application that wants to read or write a file on disk must transition to the kernel to do so, because the application itself can not execute I/O instructions. Processors provide a special instruction that switches the processor from user mode to kernel mode and enters the kernel at an entry point specified by the kernel. (The x86 processor provides the `int` instruction for this purpose.) Once the processor has switched to kernel mode, the kernel can then validate the arguments of the system call, decide whether the application is allowed to perform the requested operation, and then deny it or execute it. It is important that the kernel sets the entry point for transitions to kernel mode; if the application could decide the kernel entry point, a malicious application could enter the kernel at a point where the validation of arguments etc. is skipped.

Kernel organization

A key design question is what part of the operating system should run in kernel mode. One possibility is that the entire operating system resides in the kernel, so that the implementations of all system calls run in kernel mode. This organization is called a `monolithic kernel`.

In this organization the entire operating system runs with full hardware privilege. This organization is convenient because the OS designer doesn't have to decide which part of the operating system doesn't need full hardware privilege. Furthermore, it is easy for different parts of the operating system to cooperate. For example, an operating system might have a buffer cache that can be shared both by the file system and the virtual memory system.

A downside of the monolithic organization is that the interfaces between different parts of the operating system are often complex (as we will see in the rest of this text), and therefore it is easy for an operating system developer to make a mistake. In a monolithic kernel, a mistake is fatal, because an error in kernel mode will often result in the kernel to fail. If the kernel fails, the computer stops working, and thus all applications fail too. The computer must reboot to start again.

To reduce the risk of mistakes in the kernel, OS designers can minimize the amount of operating system code that runs in kernel mode, and execute the bulk of the operating system in user mode. This kernel organization is called a `microkernel`.

Figure 1-1 illustrates this microkernel design. In the figure, the file system runs as a user-level process. OS services running as processes are called servers. To allow applications to interact with the file server, the kernel provides an inter-process communication mechanism to send messages from one user-mode process to another. For example, if an application like the shell wants to read or write a file, it sends a message

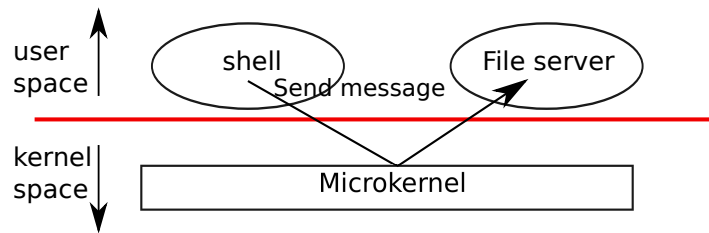

microkernel

Figure 1-1. A mkernel with a file system server

to the file server and waits for a response.

In a microkernel, the kernel interface consists of a few low-level functions for starting applications, sending messages, accessing device hardware, etc. This organization allows the kernel to be relatively simple, as most of the operating system resides in user-level servers.

process
address space
virtual address
physical address
user memory

In the real world, one can find both monolithic kernels and microkernels. For example, Linux has a monolithic kernel, although some OS functions run as user-level servers (e.g., the windowing system). Xv6 is implemented as a monolithic kernel, following most Unix operating systems. Thus, in xv6, the kernel interface corresponds to the operating system interface, and the kernel implements the complete operating system. Since xv6 doesn't provide many services, its kernel is smaller than some microkernels.

Process overview

The unit of isolation in xv6 (as in other Unix operating systems) is a process. The process abstraction prevents one process from wrecking or spying on another process' memory, CPU, file descriptors, etc. It also prevents a process from wrecking the kernel itself, so that a process can't subvert the kernel's isolation mechanisms. The kernel must implement the process abstraction with care because a buggy or malicious application may trick the kernel or hardware in doing something bad (e.g., circumventing enforced isolation). The mechanisms used by the kernel to implement processes include the user/kernel mode flag, address spaces, and time-slicing of threads.

To help enforce isolation, the process abstraction provides the illusion to a program that it has its own private machine. A process provides a program with what appears to be a private memory system, or address space, which other processes cannot read or write. A process also provides the program with what appears to be its own CPU to execute the program's instructions.

Xv6 uses page tables (which are implemented by hardware) to give each process its own address space. The x86 page table translates (or "maps") a virtual address (the address that an x86 instruction manipulates) to a physical address (an address that the processor chip sends to main memory).

Xv6 maintains a separate page table for each process that defines that process's address space. As illustrated in Figure 1-2, an address space includes the process's user memory starting at virtual address zero. Instructions come first, followed by glob-

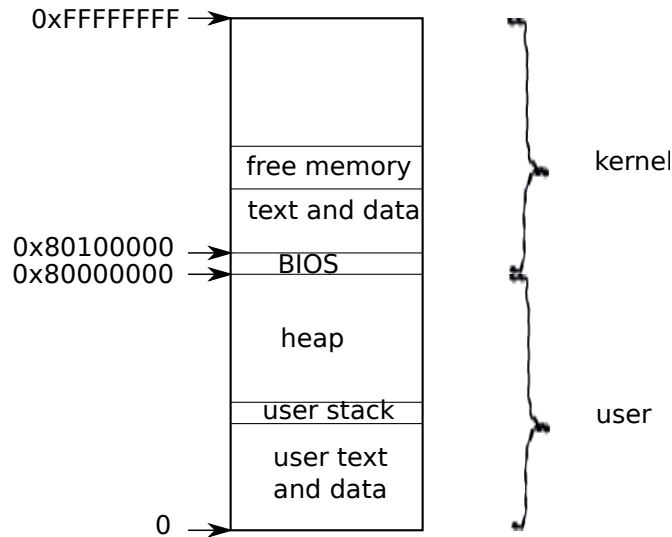

Figure 1-2. Layout of a virtual address space

al variables, then the stack, and finally a “heap” area (for malloc) that the process can expand as needed.

Each process’s address space maps the kernel’s instructions and data as well as the user program’s memory. When a process invokes a system call, the system call executes in the kernel mappings of the process’s address space. This arrangement exists so that the kernel’s system call code can directly refer to user memory. In order to leave plenty of room for user memory, xv6’s address spaces map the kernel at high addresses, starting at 0x80100000.

The xv6 kernel maintains many pieces of state for each process, which it gathers into a `struct proc` (2337). A process’s most important pieces of kernel state are its page table, its kernel stack, and its run state. We’ll use the notation `p->xxx` to refer to elements of the `proc` structure.

Each process has a thread of execution (or thread for short) that executes the process’s instructions. A thread can be suspended and later resumed. To switch transparently between processes, the kernel suspends the currently running thread and resumes another process’s thread. Much of the state of a thread (local variables, function call return addresses) is stored on the thread’s stacks. Each process has two stacks: a user stack and a kernel stack (`p->kstack`). When the process is executing user instructions, only its user stack is in use, and its kernel stack is empty. When the process enters the kernel (for a system call or interrupt), the kernel code executes on the process’s kernel stack; while a process is in the kernel, its user stack still contains saved data, but isn’t actively used. A process’s thread alternates between actively using its user stack and its kernel stack. The kernel stack is separate (and protected from user code) so that the kernel can execute even if a process has wrecked its user stack.

When a process makes a system call, the processor switches to the kernel stack, raises the hardware privilege level, and starts executing the kernel instructions that implement the system call. When the system call completes, the kernel returns to user space: the hardware lowers its privilege level, switches back to the user stack, and re-

```
struct proc+code
p->xxx+code
thread
p->kstack+code
```

sumes executing user instructions just after the system call instruction. A process's thread can "block" in the kernel to wait for I/O, and resume where it left off when the I/O has finished.

`p->state` indicates whether the process is allocated, ready to run, running, waiting for I/O, or exiting.

`p->pgdir` holds the process's page table, in the format that the x86 hardware expects. xv6 causes the paging hardware to use a process's `p->pgdir` when executing that process. A process's page table also serves as the record of the addresses of the physical pages allocated to store the process's memory.

`p->state+code`
`p->pgdir+code`
boot loader
`entry+code`
`KERNBASE+code`
`entry+code`
`entrypgdir+code`

Code: the first address space

To make the xv6 organization more concrete, we'll look how the kernel creates the first address space (for itself), how the kernel creates and starts the first process, and how that process performs the first system call. By tracing these operations we see in detail how xv6 provides strong isolation for processes. The first step in providing strong isolation is setting up the kernel to run in its own address space.

When a PC powers on, it initializes itself and then loads a boot loader from disk into memory and executes it. Appendix B explains the details. Xv6's boot loader loads the xv6 kernel from disk and executes it starting at `entry` (1044). The x86 paging hardware is not enabled when the kernel starts; virtual addresses map directly to physical addresses.

The boot loader loads the xv6 kernel into memory at physical address `0x100000`. The reason it doesn't load the kernel at `0x80100000`, where the kernel expects to find its instructions and data, is that there may not be any physical memory at such a high address on a small machine. The reason it places the kernel at `0x100000` rather than `0x0` is because the address range `0xa0000:0x100000` contains I/O devices.

To allow the rest of the kernel to run, `entry` sets up a page table that maps virtual addresses starting at `0x80000000` (called `KERNBASE` (0207)) to physical addresses starting at `0x0` (see Figure 1-2). Setting up two ranges of virtual addresses that map to the same physical memory range is a common use of page tables, and we will see more examples like this one.

The `entry` page table is defined in `main.c` (1306). We look at the details of page tables in Chapter 2, but the short story is that `entry` 0 maps virtual addresses `0:0x400000` to physical addresses `0:0x400000`. This mapping is required as long as `entry` is executing at low addresses, but will eventually be removed.

`Entry` 512 maps virtual addresses `KERNBASE:KERNBASE+0x400000` to physical addresses `0:0x400000`. This entry will be used by the kernel after `entry` has finished; it maps the high virtual addresses at which the kernel expects to find its instructions and data to the low physical addresses where the boot loader loaded them. This mapping restricts the kernel instructions and data to 4 Mbytes.

Returning to `entry`, it loads the physical address of `entrypgdir` into control register `%cr3`. The value in `%cr3` must be a physical address. It wouldn't make sense for `%cr3` to hold the virtual address of `entrypgdir`, because the paging hardware doesn't know how to translate virtual addresses yet; it doesn't have a page table yet. The sym-

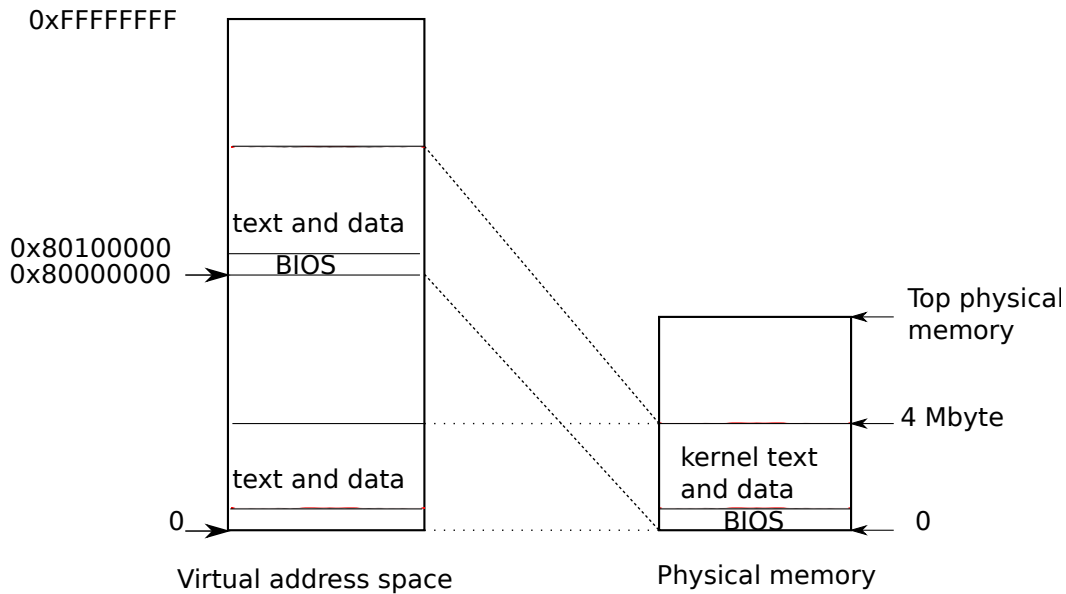

Figure 1-3. Layout of a virtual address space

`entrypgdir` refers to an address in high memory, and the macro `V2P_WO` (0213) subtracts `KERNBASE` in order to find the physical address. To enable the paging hardware, `xv6` sets the flag `CR0_PG` in the control register `%cr0`.

`V2P_WO+code`
`CR0_PG+code`
`main+code`
`main+code`
`main+code`
`allocproc+code`

The processor is still executing instructions at low addresses after paging is enabled, which works since `entrypgdir` maps low addresses. If `xv6` had omitted entry 0 from `entrypgdir`, the computer would have crashed when trying to execute the instruction after the one that enabled paging.

Now `entry` needs to transfer to the kernel's C code, and run it in high memory. First it makes the stack pointer, `%esp`, point to memory to be used as a stack (1058). All symbols have high addresses, including stack, so the stack will still be valid even when the low mappings are removed. Finally `entry` jumps to `main`, which is also a high address. The indirect jump is needed because the assembler would otherwise generate a PC-relative direct jump, which would execute the low-memory version of `main`. `main` cannot return, since there's no return PC on the stack. Now the kernel is running in high addresses in the function `main` (1217).

Code: creating the first process

Now we'll look at how the kernel creates user-level processes and ensures that they are strongly isolated.

After `main` (1217) initializes several devices and subsystems, it creates the first process by calling `userinit` (2520). `userinit`'s first action is to call `allocproc`. The job of `allocproc` (2473) is to allocate a slot (a struct `proc`) in the process table and to initialize the parts of the process's state required for its kernel thread to execute. `allocproc` is called for each new process, while `userinit` is called only for the very first process. `allocproc` scans the `proc` table for a slot with state `UNUSED` (2480-2482). When

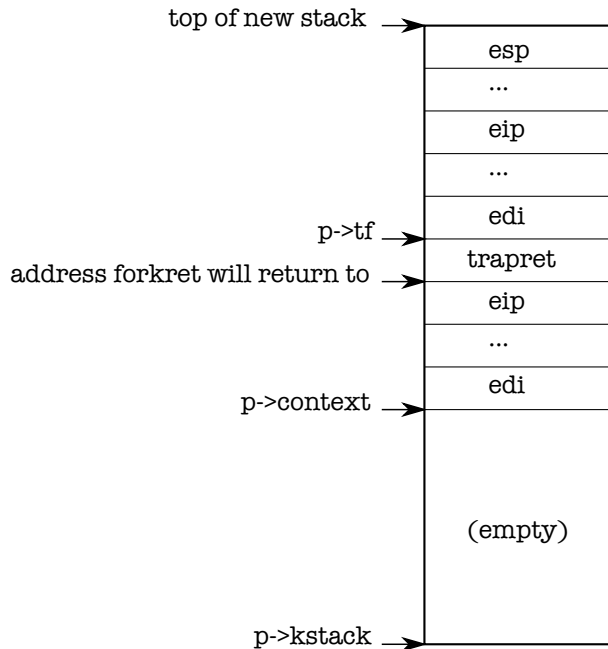

Figure 1-4. A new kernel stack.

it finds an unused slot, `allocproc` sets the state to `EMBRYO` to mark it as used and gives the process a unique `pid` (2469-2489). Next, it tries to allocate a kernel stack for the process's kernel thread. If the memory allocation fails, `allocproc` changes the state back to `UNUSED` and returns zero to signal failure.

Now `allocproc` must set up the new process's kernel stack. `allocproc` is written so that it can be used by `fork` as well as when creating the first process. `allocproc` sets up the new process with a specially prepared kernel stack and set of kernel registers that cause it to "return" to user space when it first runs. The layout of the prepared kernel stack will be as shown in Figure 1-4. `allocproc` does part of this work by setting up return program counter values that will cause the new process's kernel thread to first execute in `forkret` and then in `trapret` (2507-2512). The kernel thread will start executing with register contents copied from `p->context`. Thus setting `p->context->eip` to `forkret` will cause the kernel thread to execute at the start of `forkret` (2853). This function will return to whatever address is at the bottom of the stack. The context switch code (3058) sets the stack pointer to point just beyond the end of `p->context`. `allocproc` places `p->context` on the stack, and puts a pointer to `trapret` just above it; that is where `forkret` will return. `trapret` restores user registers from values stored at the top of the kernel stack and jumps into the process (3324). This setup is the same for ordinary `fork` and for creating the first process, though in the latter case the process will start executing at user-space location zero rather than at a return from `fork`.

As we will see in Chapter 3, the way that control transfers from user software to the kernel is via an interrupt mechanism, which is used by system calls, interrupts, and exceptions. Whenever control transfers into the kernel while a process is running, the

EMBRYO+code
pid+code
forkret+code
trapret+code
p->context+code
forkret+code
trapret+code
forkret+code
trapret+code

hardware and xv6 trap entry code save user registers on the process's kernel stack. `userinit` writes values at the top of the new stack that look just like those that would be there if the process had entered the kernel via an interrupt (2533-2539), so that the ordinary code for returning from the kernel back to the process's user code will work. These values are a `struct trapframe` which stores the user registers. Now the new process's kernel stack is completely prepared as shown in Figure 1-4.

The first process is going to execute a small program (`initcode.S`; (8400)). The process needs physical memory in which to store this program, the program needs to be copied to that memory, and the process needs a page table that maps user-space addresses to that memory.

`userinit` calls `setupkvm` (1818) to create a page table for the process with (at first) mappings only for memory that the kernel uses. We will study this function in detail in Chapter 2, but at a high level `setupkvm` and `userinit` create an address space as shown in Figure 1-2.

The initial contents of the first process's user-space memory are the compiled form of `initcode.S`; as part of the kernel build process, the linker embeds that binary in the kernel and defines two special symbols, `_binary_initcode_start` and `_binary_initcode_size`, indicating the location and size of the binary. `Userinit` copies that binary into the new process's memory by calling `inituvm`, which allocates one page of physical memory, maps virtual address zero to that memory, and copies the binary to that page (1886).

Then `userinit` sets up the trap frame (0602) with the initial user mode state: the `%cs` register contains a segment selector for the `SEG_UCODE` segment running at privilege level `DPL_USER` (i.e., user mode rather than kernel mode), and similarly `%ds`, `%es`, and `%ss` use `SEG_UDATA` with privilege `DPL_USER`. The `%eflags` `FL_IF` bit is set to allow hardware interrupts; we will reexamine this in Chapter 3.

The stack pointer `%esp` is set to the process's largest valid virtual address, `p->sz`. The instruction pointer is set to the entry point for the `initcode`, address 0.

The function `userinit` sets `p->name` to `initcode` mainly for debugging. Setting `p->cwd` sets the process's current working directory; we will examine `namei` in detail in Chapter 6.

Once the process is initialized, `userinit` marks it available for scheduling by setting `p->state` to `RUNNABLE`.

Code: Running the first process

Now that the first process's state is prepared, it is time to run it. After `main` calls `userinit`, `mpmain` calls `scheduler` to start running processes (1257). `Scheduler` (2758) looks for a process with `p->state` set to `RUNNABLE`, and there's only one: `initproc`. It sets the per-cpu variable `proc` to the process it found and calls `switchuvm` to tell the hardware to start using the target process's page table (1879). Changing page tables while executing in the kernel works because `setupkvm` causes all processes' page tables to have identical mappings for kernel code and data. `switchuvm` also sets up a task state segment `SEG_TSS` that instructs the hardware to execute system calls and interrupts on the process's kernel stack. We will re-examine the task state segment in

```

userinit+code
struct
  trapframe+code
initcode.S+code
userinit+code
setupkvm+code
initcode.S+code
_binary_initcode_start
_binary_initcode_size+
inituvm+code
SEG_UCODE+code
DPL_USER+code
SEG_UDATA+code
DPL_USER+code
FL_IF+code
userinit+code
p->name+code
p->cwd+code
namei+code
userinit+code
RUNNABLE+code
mpmain+code
scheduler+code
switchuvm+code
setupkvm+code
SEG_TSS+code

```

Chapter 3.

`scheduler` now sets `p->state` to `RUNNING` and calls `swtch` (3058) to perform a context switch to the target process's kernel thread. `swtch` first saves the current registers. The current context is not a process but rather a special per-cpu scheduler context, so `scheduler` tells `swtch` to save the current hardware registers in per-cpu storage (`cpu->scheduler`) rather than in any process's kernel thread context. `swtch` then loads the saved registers of the target kernel thread (`p->context`) into the x86 hardware registers, including the stack pointer and instruction pointer. We'll examine `swtch` in more detail in Chapter 5. The final `ret` instruction (3077) pops the target process's `%eip` from the stack, finishing the context switch. Now the processor is running on the kernel stack of process `p`.

`Allocproc` had previously set `initproc's p->context->eip` to `forkret`, so the `ret` starts executing `forkret`. On the first invocation (that is this one), `forkret` (2853) runs initialization functions that cannot be run from `main` because they must be run in the context of a regular process with its own kernel stack. Then, `forkret` returns. `Allocproc` arranged that the top word on the stack after `p->context` is popped off would be `trapret`, so now `trapret` begins executing, with `%esp` set to `p->tf`. `Trapret` (3324) uses `pop` instructions to restore registers from the trap frame (0602) just as `swtch` did with the kernel context: `popal` restores the general registers, then the `popl` instructions restore `%gs`, `%fs`, `%es`, and `%ds`. The `addl` skips over the two fields `trapno` and `errcode`. Finally, the `iret` instruction pops `%cs`, `%eip`, `%flags`, `%esp`, and `%ss` from the stack. The contents of the trap frame have been transferred to the CPU state, so the processor continues at the `%eip` specified in the trap frame. For `initproc`, that means virtual address zero, the first instruction of `initcode.S`.

At this point, `%eip` holds zero and `%esp` holds 4096. These are virtual addresses in the process's address space. The processor's paging hardware translates them into physical addresses. `allocvm` has set up the process's page table so that virtual address zero refers to the physical memory allocated for this process, and set a flag (`PTE_U`) that tells the paging hardware to allow user code to access that memory. The fact that `userinit` (2533) set up the low bits of `%cs` to run the process's user code at `CPL=3` means that the user code can only use pages with `PTE_U` set, and cannot modify sensitive hardware registers such as `%cr3`. So the process is constrained to using only its own memory.

The first system call: `exec`

Now that we have seen how the kernel provides strong isolation for processes, let's look at how a user-level process re-enters the kernel to ask for services that it cannot perform itself.

The first action of `initcode.S` is to invoke the `exec` system call. As we saw in Chapter 0, `exec` replaces the memory and registers of the current process with a new program, but it leaves the file descriptors, process id, and parent process unchanged.

`Initcode.S` (8409) begins by pushing three values on the stack—`$argv`, `$init`, and `$0`—and then sets `%eax` to `SYS_exec` and executes `int T_SYSCALL`: it is asking the kernel to run the `exec` system call. If all goes well, `exec` never returns: it starts run-

```
scheduler+code
swtch+code
cpu-
  >scheduler+code
swtch+code
ret+code
forkret+code
ret+code
forkret+code
forkret+code
main+code
p->context+code
trapret+code
swtch+code
popal+code
popl+code
addl+code
iret+code
initproc+code
initcode.S+code
allocvm+code
PTE_U+code
userinit+code
exec+code
SYS_exec+code
T_SYSCALL+code
exec+code
```

ning the program named by `$init`, which is a pointer to the NUL-terminated string `/init` (8422-8424). The other argument is the `argv` array of command-line arguments; the zero at the end of the array marks its end. If the `exec` fails and does return, `initcode` loops calling the `exit` system call, which definitely should not return (8416-8420).

`exit+code`
`/init+code`
`initcode+code`
`/init+code`

This code manually crafts the first system call to look like an ordinary system call, which we will see in Chapter 3. As before, this setup avoids special-casing the first process (in this case, its first system call), and instead reuses code that `xv6` must provide for standard operation.

Chapter 2 will cover the implementation of `exec` in detail, but at a high level it replaces `initcode` with the `/init` binary, loaded out of the file system. Now `initcode` (8400) is done, and the process will run `/init` instead. `Init` (8510) creates a new console device file if needed and then opens it as file descriptors 0, 1, and 2. Then it loops, starting a console shell, handles orphaned zombies until the shell exits, and repeats. The system is up.

Real world

Most operating systems have adopted the process concept, and most processes look similar to `xv6`'s. A real operating system would find free `proc` structures with an explicit free list in constant time instead of the linear-time search in `allocproc`; `xv6` uses the linear scan (the first of many) for simplicity.

`xv6`'s address space layout has the defect that it cannot make use of more than 2 GB of physical RAM. It's possible to fix this, though the best plan would be to switch to a machine with 64-bit addresses.

Exercises

1. Set a breakpoint at `swtch`. Single step with `gdb`'s `stepi` through the `ret` to `forkret`, then use `gdb`'s `finish` to proceed to `trapret`, then `stepi` until you get to `initcode` at virtual address zero.
2. `KERNBASE` limits the amount of memory a single process can use, which might be irritating on a machine with a full 4 GB of RAM. Would raising `KERNBASE` allow a process to use more memory?

Chapter 2

Page tables

page table entries
(PTEs)
page
page directory
page table pages
PTE_P+code

Page tables are the mechanism through which the operating system controls what memory addresses mean. They allow xv6 to multiplex the address spaces of different processes onto a single physical memory, and to protect the memories of different processes. The level of indirection provided by page tables allows many neat tricks. xv6 uses page tables primarily to multiplex address spaces and to protect memory. It also uses a few simple page-table tricks: mapping the same memory (the kernel) in several address spaces, mapping the same memory more than once in one address space (each user page is also mapped into the kernel's physical view of memory), and guarding a user stack with an unmapped page. The rest of this chapter explains the page tables that the x86 hardware provides and how xv6 uses them. Compared to a real-world operating system, xv6's design is restrictive, but it does illustrate the key ideas.

Paging hardware

As a reminder, x86 instructions (both user and kernel) manipulate virtual addresses. The machine's RAM, or physical memory, is indexed with physical addresses. The x86 page table hardware connects these two kinds of addresses, by mapping each virtual address to a physical address.

An x86 page table is logically an array of 2^{20} (1,048,576) page table entries (PTEs). Each PTE contains a 20-bit physical page number (PPN) and some flags. The paging hardware translates a virtual address by using its top 20 bits to index into the page table to find a PTE, and replacing the address's top 20 bits with the PPN in the PTE. The paging hardware copies the low 12 bits unchanged from the virtual to the translated physical address. Thus a page table gives the operating system control over virtual-to-physical address translations at the granularity of aligned chunks of 4096 (2^{12}) bytes. Such a chunk is called a page.

As shown in Figure 2-1, the actual translation happens in two steps. A page table is stored in physical memory as a two-level tree. The root of the tree is a 4096-byte page directory that contains 1024 PTE-like references to page table pages. Each page table page is an array of 1024 32-bit PTEs. The paging hardware uses the top 10 bits of a virtual address to select a page directory entry. If the page directory entry is present, the paging hardware uses the next 10 bits of the virtual address to select a PTE from the page table page that the page directory entry refers to. If either the page directory entry or the PTE is not present, the paging hardware raises a fault. This two-level structure allows a page table to omit entire page table pages in the common case in which large ranges of virtual addresses have no mappings.

Each PTE contains flag bits that tell the paging hardware how the associated virtual address is allowed to be used. PTE_P indicates whether the PTE is present: if it is

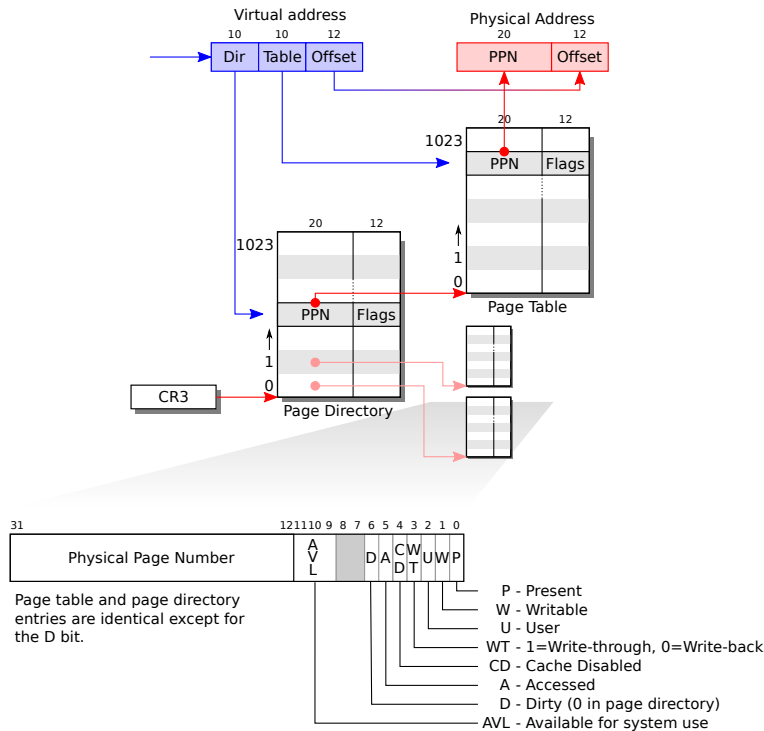

Figure 2-1. x86 page table hardware.

not set, a reference to the page causes a fault (i.e. is not allowed). PTE_W controls whether instructions are allowed to issue writes to the page; if not set, only reads and instruction fetches are allowed. PTE_U controls whether user programs are allowed to use the page; if clear, only the kernel is allowed to use the page. Figure 2-1 shows how it all works. The flags and all other page hardware related structures are defined in `mmu.h` (0700).

PTE_W+code
PTE_U+code
kvmalloc+code

A few notes about terms. Physical memory refers to storage cells in DRAM. A byte of physical memory has an address, called a physical address. Instructions use only virtual addresses, which the paging hardware translates to physical addresses, and then sends to the DRAM hardware to read or write storage. At this level of discussion there is no such thing as virtual memory, only virtual addresses.

Process address space

The page table created by entry has enough mappings to allow the kernel's C code to start running. However, `main` immediately changes to a new page table by calling `kvmalloc` (1840), because kernel has a more elaborate plan for describing process address spaces.

Each process has a separate page table, and xv6 tells the page table hardware to switch page tables when xv6 switches between processes. As shown in Figure 2-2, a process's user memory starts at virtual address zero and can grow up to `KERNBASE`, allowing a process to address up to 2 GB of memory. The file `memlayout.h` (0200) de-

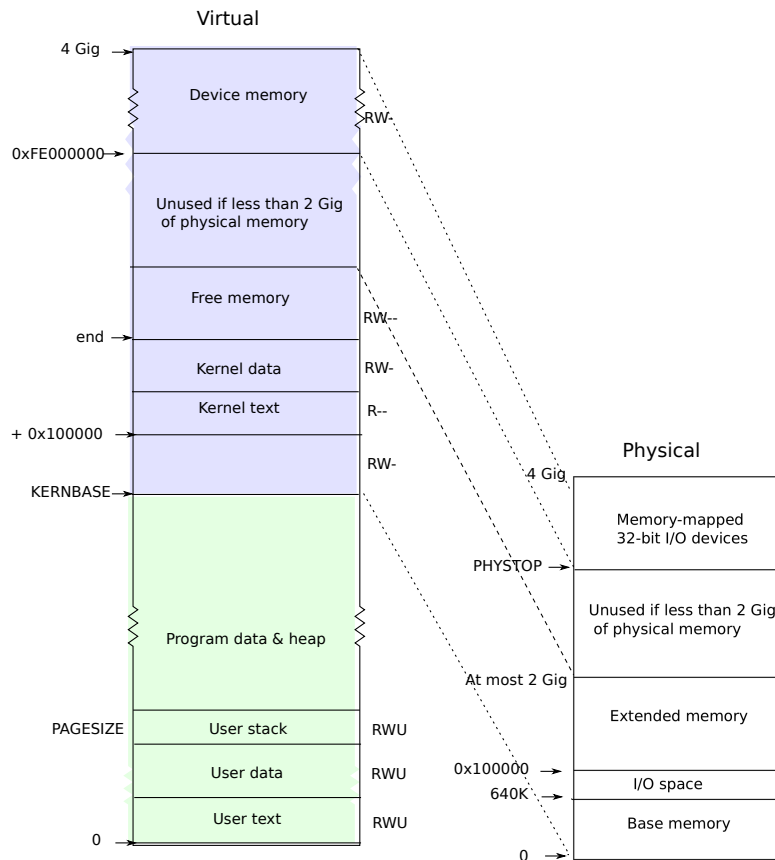

Figure 2-2. Layout of the virtual address space of a process and the layout of the physical address space. Note that if a machine has more than 2 Gbyte of physical memory, xv6 can use only the memory that fits between KERNBASE and 0xFE00000.

declares the constants for xv6's memory layout, and macros to convert virtual to physical addresses.

When a process asks xv6 for more memory, xv6 first finds free physical pages to provide the storage, and then adds PTEs to the process's page table that point to the new physical pages. xv6 sets the PTE_U, PTE_W, and PTE_P flags in these PTEs. Most processes do not use the entire user address space; xv6 leaves PTE_P clear in unused PTEs. Different processes' page tables translate user addresses to different pages of physical memory, so that each process has private user memory.

Xv6 includes all mappings needed for the kernel to run in every process's page table; these mappings all appear above KERNBASE. It maps virtual addresses KERNBASE:KERNBASE+PHYSTOP to 0:PHYSTOP. One reason for this mapping is so that the kernel can use its own instructions and data. Another reason is that the kernel sometimes needs to be able to write a given page of physical memory, for example when creating page table pages; having every physical page appear at a predictable virtual address makes this convenient. A defect of this arrangement is that xv6 cannot make use of more than 2 GB of physical memory. Some devices that use memory-mapped I/O appear at physical addresses starting at 0xFE000000, so xv6 page tables including

a direct mapping for them. Xv6 does not set the PTE_U flag in the PTEs above KERN-
BASE, so only the kernel can use them.

Having every process's page table contain mappings for both user memory and the entire kernel is convenient when switching from user code to kernel code during system calls and interrupts: such switches do not require page table switches. For the most part the kernel does not have its own page table; it is almost always borrowing some process's page table.

To review, xv6 ensures that each process can use only its own memory. And, each process sees its memory as having contiguous virtual addresses starting at zero, while the process's physical memory can be non-contiguous. xv6 implements the first by setting the PTE_U bit only on PTEs of virtual addresses that refer to the process's own memory. It implements the second using the ability of page tables to translate successive virtual addresses to whatever physical pages happen to be allocated to the process.

PTE_U+code
PTE_U+code
main+code
kvmalloc+code
setupkvm+code
mappages+code
kmap+code
PHYSTOP+code
mappages+code
walkpgdir+code
walkpgdir+code
PHYSTOP+code

Code: creating an address space

`main` calls `kvmalloc` (1840) to create and switch to a page table with the mappings above KERNBASE required for the kernel to run. Most of the work happens in `setupkvm` (1818). It first allocates a page of memory to hold the page directory. Then it calls `mappages` to install the translations that the kernel needs, which are described in the `kmap` (1809) array. The translations include the kernel's instructions and data, physical memory up to PHYSTOP, and memory ranges which are actually I/O devices. `setupkvm` does not install any mappings for the user memory; this will happen later.

`mappages` (1760) installs mappings into a page table for a range of virtual addresses to a corresponding range of physical addresses. It does this separately for each virtual address in the range, at page intervals. For each virtual address to be mapped, `mappages` calls `walkpgdir` to find the address of the PTE for that address. It then initializes the PTE to hold the relevant physical page number, the desired permissions (PTE_W and/or PTE_U), and PTE_P to mark the PTE as valid (1772).

`walkpgdir` (1735) mimics the actions of the x86 paging hardware as it looks up the PTE for a virtual address (see Figure 2-1). `walkpgdir` uses the upper 10 bits of the virtual address to find the page directory entry (1740). If the page directory entry isn't present, then the required page table page hasn't yet been allocated; if the `alloc` argument is set, `walkpgdir` allocates it and puts its physical address in the page directory. Finally it uses the next 10 bits of the virtual address to find the address of the PTE in the page table page (1753).

Physical memory allocation

The kernel must allocate and free physical memory at run-time for page tables, process user memory, kernel stacks, and pipe buffers.

xv6 uses the physical memory between the end of the kernel and PHYSTOP for run-time allocation. It allocates and frees whole 4096-byte pages at a time. It keeps track of which pages are free by threading a linked list through the pages themselves. Allocation consists of removing a page from the linked list; freeing consists of adding

the freed page to the list.

There is a bootstrap problem: all of physical memory must be mapped in order for the allocator to initialize the free list, but creating a page table with those mappings involves allocating page-table pages. xv6 solves this problem by using a separate page allocator during entry, which allocates memory just after the end of the kernel's data segment. This allocator does not support freeing and is limited by the 4 MB mapping in the `entrypgdir`, but that is sufficient to allocate the first kernel page table.

```
struct run+code
main+code
kinit1+code
kinit2+code
PHYSTOP+code
freerange+code
kfree+code
PGROUNDUP+code
type cast
kalloc+code
```

Code: Physical memory allocator

The allocator's data structure is a *free list* of physical memory pages that are available for allocation. Each free page's list element is a `struct run` (3115). Where does the allocator get the memory to hold that data structure? It store each free page's run structure in the free page itself, since there's nothing else stored there. The free list is protected by a spin lock (3119-3123). The list and the lock are wrapped in a struct to make clear that the lock protects the fields in the struct. For now, ignore the lock and the calls to `acquire` and `release`; Chapter 4 will examine locking in detail.

The function `main` calls `kinit1` and `kinit2` to initialize the allocator (3131). The reason for having two calls is that for much of `main` one cannot use locks or memory above 4 megabytes. The call to `kinit1` sets up for lock-less allocation in the first 4 megabytes, and the call to `kinit2` enables locking and arranges for more memory to be allocatable. `main` ought to determine how much physical memory is available, but this turns out to be difficult on the x86. Instead it assumes that the machine has 240 megabytes (`PHYSTOP`) of physical memory, and uses all the memory between the end of the kernel and `PHYSTOP` as the initial pool of free memory. `kinit1` and `kinit2` call `freerange` to add memory to the free list via per-page calls to `kfree`. A PTE can only refer to a physical address that is aligned on a 4096-byte boundary (is a multiple of 4096), so `freerange` uses `PGROUNDUP` to ensure that it frees only aligned physical addresses. The allocator starts with no memory; these calls to `kfree` give it some to manage.

The allocator refers to physical pages by their virtual addresses as mapped in high memory, not by their physical addresses, which is why `kinit` uses `P2V(PHYSTOP)` to translate `PHYSTOP` (a physical address) to a virtual address. The allocator sometimes treats addresses as integers in order to perform arithmetic on them (e.g., traversing all pages in `kinit`), and sometimes uses addresses as pointers to read and write memory (e.g., manipulating the run structure stored in each page); this dual use of addresses is the main reason that the allocator code is full of C type casts. The other reason is that freeing and allocation inherently change the type of the memory.

The function `kfree` (3164) begins by setting every byte in the memory being freed to the value 1. This will cause code that uses memory after freeing it (uses "dangling references") to read garbage instead of the old valid contents; hopefully that will cause such code to break faster. Then `kfree` casts `v` to a pointer to `struct run`, records the old start of the free list in `r->next`, and sets the free list equal to `r`. `kalloc` removes and returns the first element in the free list.

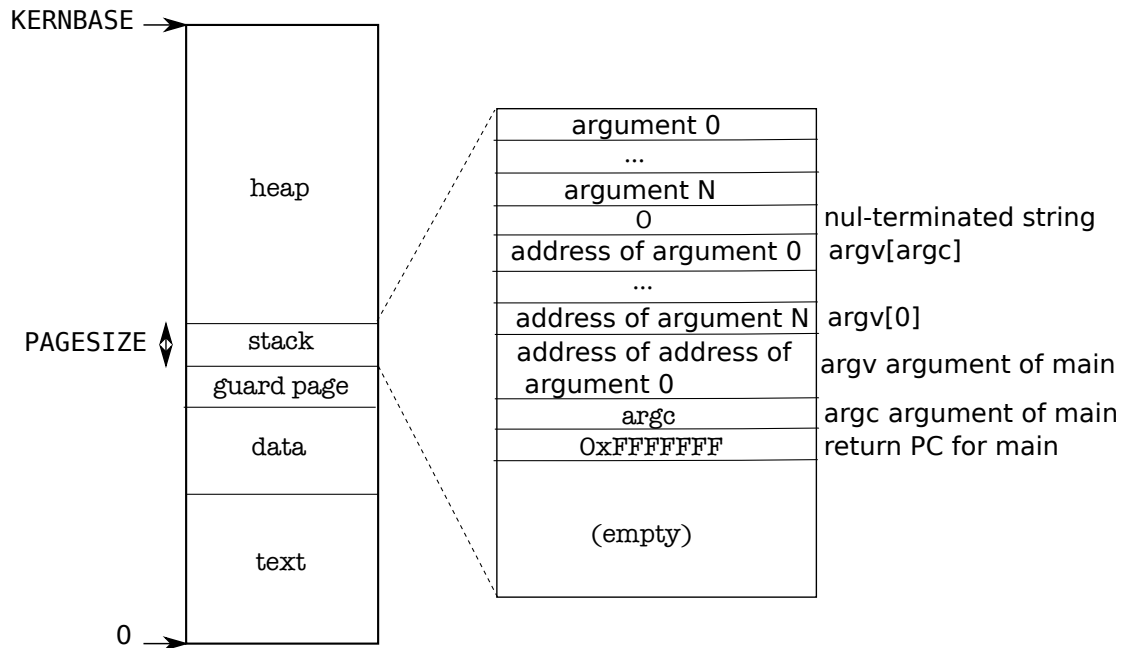

Figure 2-3. Memory layout of a user process with its initial stack.

User part of an address space

sbrk+code

Figure 2-3 shows the layout of the user memory of an executing process in xv6. Each user process starts at address 0. The bottom of the address space contains the text for the user program, its data, and its stack. The heap is above the stack so that the heap can expand when the process calls `sbrk`. Note that the text, data, and stack sections are laid out contiguously in the process's address space but xv6 is free to use non-contiguous physical pages for those sections. For example, when xv6 expands a process's heap, it can use any free physical page for the new virtual page and then program the page table hardware to map the virtual page to the allocated physical page. This flexibility is a major advantage of using paging hardware.

The stack is a single page, and is shown with the initial contents as created by `exec`. Strings containing the command-line arguments, as well as an array of pointers to them, are at the very top of the stack. Just under that are values that allow a program to start at `main` as if the function call `main(argc, argv)` had just started. To guard a stack growing off the stack page, xv6 places a guard page right below the stack. The guard page is not mapped and so if the stack runs off the stack page, the hardware will generate an exception because it cannot translate the faulting address. A real-world operating system might allocate more space for the stack so that it can grow beyond one page.

Code: `sbrk`

`Sbrk` is the system call for a process to shrink or grow its memory. The system call is implemented by the function `growproc` (2558). If `n` is positive, `growproc` allocates one

or more physical pages and maps them at the top of the process's address space. If `n` is negative, `growproc` unmaps one or more pages from the process's address space and frees the corresponding physical pages. To make these changes, `xv6` modifies the process's page table. The process's page table is stored in memory, and so the kernel can update the table with ordinary assignment statements, which is what `allocuvm` and `deallocuvm` do. The x86 hardware caches page table entries in a Translation Look-aside Buffer (TLB), and when `xv6` changes the page tables, it must invalidate the cached entries. If it didn't invalidate the cached entries, then at some point later the TLB might use an old mapping, pointing to a physical page that in the mean time has been allocated to another process, and as a result, a process might be able to scribble on some other process's memory. `Xv6` invalidates stale cached entries, by reloading `cr3`, the register that holds the address of the current page table.

Translation Look-aside Buffer (TLB)
 namei+code
 ELF format
 struct elfhdr+code
 ELF_MAGIC+code
 setupkvm+code
 allocuvm+code
 loaduvm+code
 loaduvm+code
 walkpgdir+code
 readi+code
 /init+code

Code: `exec`

`Exec` is the system call that creates the user part of an address space. It initializes the user part of an address space from a file stored in the file system. `Exec` (6610) opens the named binary path using `namei` (6623), which is explained in Chapter 6. Then, it reads the ELF header. `Xv6` applications are described in the widely-used ELF format, defined in `elf.h`. An ELF binary consists of an ELF header, `struct elfhdr` (0955), followed by a sequence of program section headers, `struct proghdr` (0974). Each `proghdr` describes a section of the application that must be loaded into memory; `xv6` programs have only one program section header, but other systems might have separate sections for instructions and data.

The first step is a quick check that the file probably contains an ELF binary. An ELF binary starts with the four-byte “magic number” `0x7F, 'E', 'L', 'F'`, or `ELF_MAGIC` (0952). If the ELF header has the right magic number, `exec` assumes that the binary is well-formed.

`Exec` allocates a new page table with no user mappings with `setupkvm` (6637), allocates memory for each ELF segment with `allocuvm` (6651), and loads each segment into memory with `loaduvm` (6655). `allocuvm` checks that the virtual addresses requested is below `KERNBASE`. `loaduvm` (1903) uses `walkpgdir` to find the physical address of the allocated memory at which to write each page of the ELF segment, and `readi` to read from the file.

The program section header for `/init`, the first user program created with `exec`, looks like this:

```
# objdump -p _init

_init:      file format elf32-i386

Program Header:
  LOAD off   0x00000054 vaddr 0x00000000 paddr 0x00000000 align 2**2
          filesz 0x000008c0 memsz 0x000008cc flags rwx
```

The program section header's `filesz` may be less than the `memsz`, indicating that the gap between them should be filled with zeroes (for C global variables) rather than

read from the file. For `/init`, `filesz` is 2240 bytes and `memsz` is 2252 bytes, and thus `allocvm` allocates enough physical memory to hold 2252 bytes, but reads only 2240 bytes from the file `/init`.

`allocvm+code`
`exec+code`
`ustack+code`
`argv+code`
`argc+code`
`copyout+code`

Now `exec` allocates and initializes the user stack. It allocates just one stack page. `Exec` copies the argument strings to the top of the stack one at a time, recording the pointers to them in `ustack`. It places a null pointer at the end of what will be the `argv` list passed to `main`. The first three entries in `ustack` are the fake return PC, `argc`, and `argv` pointer.

`Exec` places an inaccessible page just below the stack page, so that programs that try to use more than one page will fault. This inaccessible page also allows `exec` to deal with arguments that are too large; in that situation, the `copyout` (2118) function that `exec` uses to copy arguments to the stack will notice that the destination page is not accessible, and will return `-1`.

During the preparation of the new memory image, if `exec` detects an error like an invalid program segment, it jumps to the label `bad`, frees the new image, and returns `-1`. `Exec` must wait to free the old image until it is sure that the system call will succeed: if the old image is gone, the system call cannot return `-1` to it. The only error cases in `exec` happen during the creation of the image. Once the image is complete, `exec` can install the new image (6701) and free the old one (6702). Finally, `exec` returns 0.

`Exec` loads bytes from the ELF file into memory at addresses specified by the ELF file. Users or processes can place whatever addresses they want into an ELF file. Thus `exec` is risky, because the addresses in the ELF file may refer to the kernel, accidentally or on purpose. The consequences for an unwary kernel could range from a crash to a malicious subversion of the kernel's isolation mechanisms (i.e., a security exploit). `xv6` performs a number of checks to avoid these risks. To understand the importance of these checks, consider what could happen if `xv6` didn't check `if(ph.vaddr + ph.memsz < ph.vaddr)`. This is a check for whether the sum overflows a 32-bit integer. The danger is that a user could construct an ELF binary with a `ph.vaddr` that points into the kernel, and `ph.memsz` large enough that the sum overflows to `0x1000`. Since the sum is small, it would pass the check `if(newsz >= KERNBASE)` in `allocvm`. The subsequent call to `loadvm` passes `ph.vaddr` by itself, without adding `ph.memsz` and without checking `ph.vaddr` against `KERNBASE`, and would thus copy data from the ELF binary into the kernel. This could be exploited by a user program to run arbitrary user code with kernel privileges. As this example illustrates, argument checking must be done with great care. It is easy for a kernel developer to omit a crucial check, and real-world kernels have a long history of missing checks whose absence can be exploited by user programs to obtain kernel privileges. It is likely that `xv6` doesn't do a complete job of validating user-level data supplied to the kernel, which a malicious user program might be able to exploit to circumvent `xv6`'s isolation.

Real world

Like most operating systems, `xv6` uses the paging hardware for memory protection and mapping. Most operating systems use `x86`'s 64-bit paging hardware (which

has 3 levels of translation). 64-bit address spaces allow for a less restrictive memory layout than xv6's; for example, it would be easy to remove xv6's limit of 2 Gbyte for physical memory. Most operating systems make far more sophisticated use of paging than xv6; for example, xv6 lacks demand paging from disk, copy-on-write fork, shared memory, lazily-allocated pages, and automatically extending stacks. The x86 supports address translation using segmentation (see Appendix B), but xv6 uses segments only for the common trick of implementing per-cpu variables such as `proc` that are at a fixed address but have different values on different CPUs (see `seginit`). Implementations of per-CPU (or per-thread) storage on non-segment architectures would dedicate a register to holding a pointer to the per-CPU data area, but the x86 has so few general registers that the extra effort required to use segmentation is worthwhile.

On machines with lots of memory it might make sense to use the x86's 4 Mbyte "super pages." Small pages make sense when physical memory is small, to allow allocation and page-out to disk with fine granularity. For example, if a program uses only 8 Kbyte of memory, giving it a 4 Mbyte physical page is wasteful. Larger pages make sense on machines with lots of RAM, and may reduce overhead for page-table manipulation. Xv6 uses super pages in one place: the initial page table (1306). The array initialization sets two of the 1024 PDEs, at indices zero and 512 (`KERNBASE >> PDXSHIFT`), leaving the other PDEs zero. Xv6 sets the `PTE_PS` bit in these two PDEs to mark them as super pages. The kernel also tells the paging hardware to allow super pages by setting the `CR_PSE` bit (Page Size Extension) in `%cr4`.

Xv6 should determine the actual RAM configuration, instead of assuming 240 MB. On the x86, there are at least three common algorithms: the first is to probe the physical address space looking for regions that behave like memory, preserving the values written to them; the second is to read the number of kilobytes of memory out of a known 16-bit location in the PC's non-volatile RAM; and the third is to look in BIOS memory for a memory layout table left as part of the multiprocessor tables. Reading the memory layout table is complicated.

Memory allocation was a hot topic a long time ago, the basic problems being efficient use of limited memory and preparing for unknown future requests; see Knuth. Today people care more about speed than space-efficiency. In addition, a more elaborate kernel would likely allocate many different sizes of small blocks, rather than (as in xv6) just 4096-byte blocks; a real kernel allocator would need to handle small allocations as well as large ones.

Exercises

1. Look at real operating systems to see how they size memory.
2. If xv6 had not used super pages, what would be the right declaration for `entrypgdir`?
3. Write a user program that grows its address space with 1 byte by calling `sbrk(1)`. Run the program and investigate the page table for the program before the call to `sbrk` and after the call to `sbrk`. How much space has the kernel allocated? What does the `pte` for the new memory contain?
4. Modify xv6 so that the pages for the kernel are shared among processes, which

reduces memory consumption.

5. Unix implementations of `exec` traditionally include special handling for shell scripts. If the file to execute begins with the text `#!`, then the first line is taken to be a program to run to interpret the file. For example, if `exec` is called to run `myprog arg1` and `myprog`'s first line is `#!/interp`, then `exec` runs `/interp` with command line `/interp myprog arg1`. Implement support for this convention in `xv6`.

6. Delete the check `if(ph.vaddr + ph.memsz < ph.vaddr)` in `exec.c`, and construct a user program that exploits that the check is missing.

7. How would you improve `xv6`'s memory layout if `xv6` were running on a 64-bit processor?

Chapter 3

Traps, interrupts, and drivers

When running a process, a CPU executes the normal processor loop: read an instruction, advance the program counter, execute the instruction, repeat. But there are events on which control from a user program must transfer back to the kernel instead of executing the next instruction. These events include a device signaling that it wants attention, a user program doing something illegal (e.g., references a virtual address for which there is no page table entry), or a user program asking the kernel for a service with a system call. There are three main challenges in handling these events: 1) the kernel must arrange that a processor switches from user mode to kernel mode (and back); 2) the kernel and devices must coordinate their parallel activities; and 3) the kernel must understand the interface of the devices. Addressing these 3 challenges requires detailed understanding of hardware and careful programming, and can result in opaque kernel code. This chapter explains how xv6 addresses these three challenges.

Systems calls, exceptions, and interrupts

There are three cases when control must be transferred from a user program to the kernel. First, a system call: when a user program asks for an operating system service, as we saw at the end of the last chapter. Second, an exception: when a program performs an illegal action. Examples of illegal actions include divide by zero, attempt to access memory for a page-table entry that is not present, and so on. Third, an interrupt: when a device generates a signal to indicate that it needs attention from the operating system. For example, a clock chip may generate an interrupt every 100 msec to allow the kernel to implement time sharing. As another example, when the disk has read a block from disk, it generates an interrupt to alert the operating system that the block is ready to be retrieved.

The kernel handles all interrupts, rather than processes handling them, because in most cases only the kernel has the required privilege and state. For example, in order to time-slice among processes in response to the clock interrupts, the kernel must be involved, if only to force uncooperative processes to yield the processor.

In all three cases, the operating system design must arrange for the following to happen. The system must save the processor's registers for future transparent resume. The system must be set up for execution in the kernel. The system must choose a place for the kernel to start executing. The kernel must be able to retrieve information about the event, e.g., system call arguments. It must all be done securely; the system must maintain isolation of user processes and the kernel.

To achieve this goal the operating system must be aware of the details of how the hardware handles system calls, exceptions, and interrupts. In most processors these three events are handled by a single hardware mechanism. For example, on the x86, a

program invokes a system call by generating an interrupt using the `int` instruction. Similarly, exceptions generate an interrupt too. Thus, if the operating system has a plan for interrupt handling, then the operating system can handle system calls and exceptions too.

int+code
interrupt handler
traps
kernel mode
user mode

The basic plan is as follows. An interrupt stops the normal processor loop and starts executing a new sequence called an `interrupt handler`. Before starting the interrupt handler, the processor saves its registers, so that the operating system can restore them when it returns from the interrupt. A challenge in the transition to and from the interrupt handler is that the processor should switch from user mode to kernel mode, and back.

A word on terminology: Although the official x86 term is `interrupt`, xv6 refers to all of these as `traps`, largely because it was the term used by the PDP11/40 and therefore is the conventional Unix term. This chapter uses the terms `trap` and `interrupt` interchangeably, but it is important to remember that traps are caused by the current process running on a processor (e.g., the process makes a system call and as a result generates a trap), and interrupts are caused by devices and may not be related to the currently running process. For example, a disk may generate an interrupt when it is done retrieving a block for one process, but at the time of the interrupt some other process may be running. This property of interrupts makes thinking about interrupts more difficult than thinking about traps, because interrupts happen concurrently with other activities. Both rely, however, on the same hardware mechanism to transfer control between user and kernel mode securely, which we will discuss next.

X86 protection

The x86 has 4 protection levels, numbered 0 (most privilege) to 3 (least privilege). In practice, most operating systems use only 2 levels: 0 and 3, which are then called `kernel mode` and `user mode`, respectively. The current privilege level with which the x86 executes instructions is stored in `%cs` register, in the field `CPL`.

On the x86, interrupt handlers are defined in the `interrupt descriptor table (IDT)`. The IDT has 256 entries, each giving the `%cs` and `%eip` to be used when handling the corresponding interrupt.

To make a system call on the x86, a program invokes the `int n` instruction, where `n` specifies the index into the IDT. The `int` instruction performs the following steps:

- Fetch the `n`'th descriptor from the IDT, where `n` is the argument of `int`.
- Check that `CPL` in `%cs` is \leq `DPL`, where `DPL` is the privilege level in the descriptor.
- Save `%esp` and `%ss` in CPU-internal registers, but only if the target segment selector's `PL` $<$ `CPL`.
- Load `%ss` and `%esp` from a task segment descriptor.
- Push `%ss`.

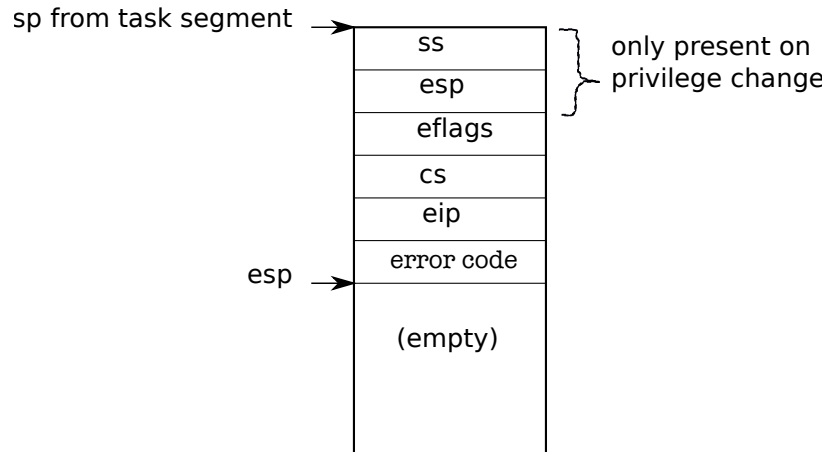

Figure 3-1. Kernel stack after an `int` instruction.

- Push `%esp`.
- Push `%eflags`.
- Push `%cs`.
- Push `%eip`.
- Clear the IF bit in `%eflags`, but only on an interrupt.
- Set `%cs` and `%eip` to the values in the descriptor.

`int+code`
`iret+code`
`int+code`
`initcode.S+code`

The `int` instruction is a complex instruction, and one might wonder whether all these actions are necessary. For example, the check `CPL <= DPL` allows the kernel to forbid `int` calls to inappropriate IDT entries such as device interrupt routines. For a user program to execute `int`, the IDT entry's DPL must be 3. If the user program doesn't have the appropriate privilege, then `int` will result in `int 13`, which is a general protection fault. As another example, the `int` instruction cannot use the user stack to save values, because the process may not have a valid stack pointer; instead, the hardware uses the stack specified in the task segment, which is set by the kernel.

Figure 3-1 shows the stack after an `int` instruction completes and there was a privilege-level change (the privilege level in the descriptor is lower than CPL). If the `int` instruction didn't require a privilege-level change, the x86 won't save `%ss` and `%esp`. After both cases, `%eip` is pointing to the address specified in the descriptor table, and the instruction at that address is the next instruction to be executed and the first instruction of the handler for `int n`. It is job of the operating system to implement these handlers, and below we will see what xv6 does.

An operating system can use the `iret` instruction to return from an `int` instruction. It pops the saved values during the `int` instruction from the stack, and resumes execution at the saved `%eip`.

Code: The first system call

Chapter 1 ended with `initcode.S` invoking a system call. Let's look at that again

(8414). The process pushed the arguments for an `exec` call on the process's stack, and put the system call number in `%eax`. The system call numbers match the entries in the `syscalls` array, a table of function pointers (3672). We need to arrange that the `int` instruction switches the processor from user mode to kernel mode, that the kernel invokes the right kernel function (i.e., `sys_exec`), and that the kernel can retrieve the arguments for `sys_exec`. The next few subsections describe how xv6 arranges this for system calls, and then we will discover that we can reuse the same code for interrupts and exceptions.

`exec+code`
`sys_exec+code`
`int+code`
`tvinit`
`main+code`
`idt+code`
`vectors[i]+code`
`T_SYSCALL+code`
`IF+code`
`DPL_USER+code`
`switchvm+code`
`alltraps+code`

Code: Assembly trap handlers

Xv6 must set up the x86 hardware to do something sensible on encountering an `int` instruction, which causes the processor to generate a trap. The x86 allows for 256 different interrupts. Interrupts 0-31 are defined for software exceptions, like divide errors or attempts to access invalid memory addresses. Xv6 maps the 32 hardware interrupts to the range 32-63 and uses interrupt 64 as the system call interrupt.

`tvinit` (3367), called from `main`, sets up the 256 entries in the table `idt`. Interrupt `i` is handled by the code at the address in `vectors[i]`. Each entry point is different, because the x86 does not provide the trap number to the interrupt handler. Using 256 different handlers is the only way to distinguish the 256 cases.

`tvinit` handles `T_SYSCALL`, the user system call trap, specially: it specifies that the gate is of type “trap” by passing a value of 1 as second argument. Trap gates don't clear the `IF` flag, allowing other interrupts during the system call handler.

The kernel also sets the system call gate privilege to `DPL_USER`, which allows a user program to generate the trap with an explicit `int` instruction. xv6 doesn't allow processes to raise other interrupts (e.g., device interrupts) with `int`; if they try, they will encounter a general protection exception, which goes to vector 13.

When changing protection levels from user to kernel mode, the kernel shouldn't use the stack of the user process, because it may not be valid. The user process may be malicious or contain an error that causes the user `%esp` to contain an address that is not part of the process's user memory. Xv6 programs the x86 hardware to perform a stack switch on a trap by setting up a task segment descriptor through which the hardware loads a stack segment selector and a new value for `%esp`. The function `switchvm` (1860) stores the address of the top of the kernel stack of the user process into the task segment descriptor.

When a trap occurs, the processor hardware does the following. If the processor was executing in user mode, it loads `%esp` and `%ss` from the task segment descriptor, pushes the old user `%ss` and `%esp` onto the new stack. If the processor was executing in kernel mode, none of the above happens. The processor then pushes the `%eflags`, `%cs`, and `%eip` registers. For some traps (e.g., a page fault), the processor also pushes an error word. The processor then loads `%eip` and `%cs` from the relevant IDT entry.

xv6 uses a Perl script (3250) to generate the entry points that the IDT entries point to. Each entry pushes an error code if the processor didn't, pushes the interrupt number, and then jumps to `alltraps`.

`Alltraps` (3304) continues to save processor registers: it pushes `%ds`, `%es`, `%fs`,

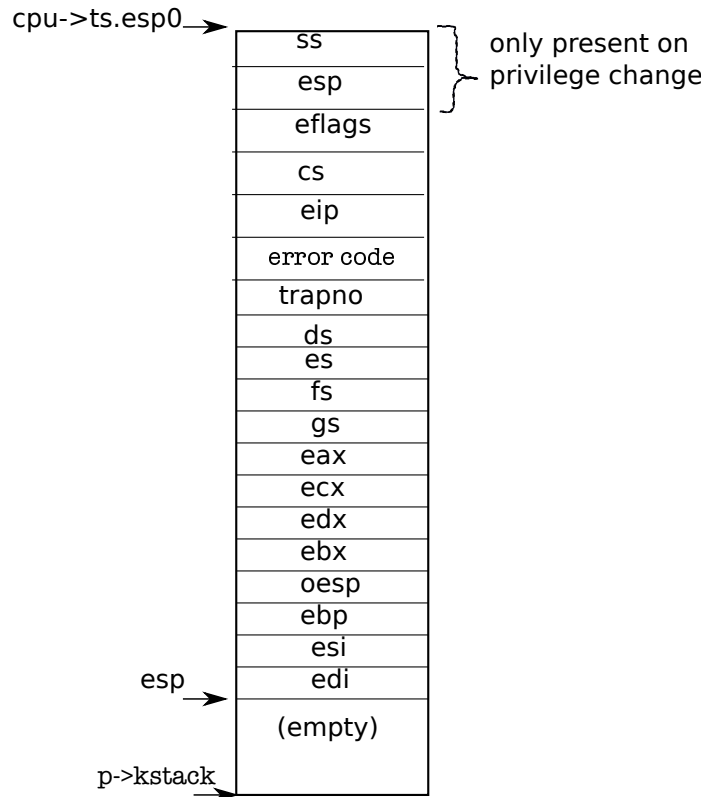

Figure 3-2. The trapframe on the kernel stack

`%gs`, and the general-purpose registers (3305-3310). The result of this effort is that the kernel stack now contains a `struct trapframe` (0602) containing the processor registers at the time of the trap (see Figure 3-2). The processor pushes `%ss`, `%esp`, `%eflags`, `%cs`, and `%eip`. The processor or the trap vector pushes an error number, and `alltraps` pushes the rest. The trap frame contains all the information necessary to restore the user mode processor registers when the kernel returns to the current process, so that the processor can continue exactly as it was when the trap started. Recall from Chapter 2, that `userinit` built a trapframe by hand to achieve this goal (see Figure 1-4).

`alltraps+code`
`alltraps+code`
`alltraps+code`
`trap+code`
`alltraps+code`

In the case of the first system call, the saved `%eip` is the address of the instruction right after the `int` instruction. `%cs` is the user code segment selector. `%eflags` is the content of the `%eflags` register at the point of executing the `int` instruction. As part of saving the general-purpose registers, `alltraps` also saves `%eax`, which contains the system call number for the kernel to inspect later.

Now that the user mode processor registers are saved, `alltraps` can finish setting up the processor to run kernel C code. The processor set the selectors `%cs` and `%ss` before entering the handler; `alltraps` sets `%ds` and `%es` (3313-3315).

Once the segments are set properly, `alltraps` can call the C trap handler `trap`. It pushes `%esp`, which points at the trap frame it just constructed, onto the stack as an argument to `trap` (3318). Then it calls `trap` (3319). After `trap` returns, `alltraps` pops the argument off the stack by adding to the stack pointer (3320) and then starts execut-

ing the code at label `trapret`. We traced through this code in Chapter 2 when the first user process ran it to exit to user space. The same sequence happens here: popping through the trap frame restores the user mode registers and then `iret` jumps back into user space.

The discussion so far has talked about traps occurring in user mode, but traps can also happen while the kernel is executing. In that case the hardware does not switch stacks or save the stack pointer or stack segment selector; otherwise the same steps occur as in traps from user mode, and the same xv6 trap handling code executes. When `iret` later restores a kernel mode `%cs`, the processor continues executing in kernel mode.

```
trapret+code
iret+code
trap+code
tf->trapno+code
T_SYSCALL+code
syscall+code
proc->killed+code
trap+code
panic+code
trap+code
syscall+code
SYS_exec+code
cp->tf+code
syscall+code
```

Code: C trap handler

We saw in the last section that each handler sets up a trap frame and then calls the C function `trap`. `Trap` (3401) looks at the hardware trap number `tf->trapno` to decide why it has been called and what needs to be done. If the trap is `T_SYSCALL`, `trap` calls the system call handler `syscall`. We'll revisit the `proc->killed` checks in Chapter 5.

After checking for a system call, `trap` looks for hardware interrupts (which we discuss below). In addition to the expected hardware devices, a trap can be caused by a spurious interrupt, an unwanted hardware interrupt.

If the trap is not a system call and not a hardware device looking for attention, `trap` assumes it was caused by incorrect behavior (e.g., divide by zero) as part of the code that was executing before the trap. If the code that caused the trap was a user program, xv6 prints details and then sets `proc->killed` to remember to clean up the user process. We will look at how xv6 does this cleanup in Chapter 5.

If it was the kernel running, there must be a kernel bug: `trap` prints details about the surprise and then calls `panic`.

Code: System calls

For system calls, `trap` invokes `syscall` (3701). `Syscall` loads the system call number from the trap frame, which contains the saved `%eax`, and indexes into the system call tables. For the first system call, `%eax` contains the value `SYS_exec` (3507), and `syscall` will invoke the `SYS_exec`'th entry of the system call table, which corresponds to invoking `sys_exec`.

`Syscall` records the return value of the system call function in `%eax`. When the trap returns to user space, it will load the values from `cp->tf` into the machine registers. Thus, when `exec` returns, it will return the value that the system call handler returned (3708). System calls conventionally return negative numbers to indicate errors, positive numbers for success. If the system call number is invalid, `syscall` prints an error and returns `-1`.

Later chapters will examine the implementation of particular system calls. This chapter is concerned with the mechanisms for system calls. There is one bit of mechanism left: finding the system call arguments. The helper functions `argint`, `argptr`, `argstr`,

and `argfd` retrieve the n 'th system call argument, as either an integer, pointer, a string, or a file descriptor. `argint` uses the user-space `%esp` register to locate the n 'th argument: `%esp` points at the return address for the system call stub. The arguments are right above it, at `%esp+4`. Then the n th argument is at `%esp+4+4*n`.

`argint+code`
`fetchint+code`
`p->sz+code`
`argptr+code`
`argstr+code`
`argfd+code`

`argint` calls `fetchint` to read the value at that address from user memory and write it to `*ip`. `fetchint` can simply cast the address to a pointer, because the user and the kernel share the same page table, but the kernel must verify that the pointer lies within the user part of the address space. The kernel has set up the page-table hardware to make sure that the process cannot access memory outside its local private memory: if a user program tries to read or write memory at an address of `p->sz` or above, the processor will cause a segmentation trap, and trap will kill the process, as we saw above. The kernel, however, can dereference any address that the user might have passed, so it must check explicitly that the address is below `p->sz`.

`argptr` fetches the n th system call argument and checks that this argument is a valid user-space pointer. Note that two checks occur during a call to `argptr`. First, the user stack pointer is checked during the fetching of the argument. Then the argument, itself a user pointer, is checked.

`argstr` interprets the n th argument as a pointer. It ensures that the pointer points at a NUL-terminated string and that the complete string is located below the end of the user part of the address space.

Finally, `argfd` (6071) uses `argint` to retrieve a file descriptor number, checks if it is valid file descriptor, and returns the corresponding `struct file`.

The system call implementations (for example, `sysproc.c` and `sysfile.c`) are typically wrappers: they decode the arguments using `argint`, `argptr`, and `argstr` and then call the real implementations. In chapter 2, `sys_exec` uses these functions to get at its arguments.

Code: Interrupts

Devices on the motherboard can generate interrupts, and `xv6` must set up the hardware to handle these interrupts. Devices usually interrupt in order to tell the kernel that some hardware event has occurred, such as I/O completion. Interrupts are usually optional in the sense that the kernel could instead periodically check (or "poll") the device hardware to check for new events. Interrupts are preferable to polling if the events are relatively rare, so that polling would waste CPU time. Interrupt handling shares some of the code already needed for system calls and exceptions.

Interrupts are similar to system calls, except devices generate them at any time. There is hardware on the motherboard to signal the CPU when a device needs attention (e.g., the user has typed a character on the keyboard). We must program the device to generate an interrupt, and arrange that a CPU receives the interrupt.

Let's look at the timer device and timer interrupts. We would like the timer hardware to generate an interrupt, say, 100 times per second so that the kernel can track the passage of time and so the kernel can time-slice among multiple running processes. The choice of 100 times per second allows for decent interactive performance while not swamping the processor with handling interrupts.

Like the x86 processor itself, PC motherboards have evolved, and the way interrupts are provided has evolved too. The early boards had a simple programmable interrupt controller (called the PIC). With the advent of multiprocessor PC boards, a new way of handling interrupts was needed, because each CPU needs an interrupt controller to handle interrupts sent to it, and there must be a method for routing interrupts to processors. This way consists of two parts: a part that is in the I/O system (the IO APIC, `ioapic.c`), and a part that is attached to each processor (the local APIC, `lapic.c`). Xv6 is designed for a board with multiple processors: it ignores interrupts from the PIC, and configures the IOAPIC and local APIC.

lapicinit+code
IRQ_TIMER,+code
IF+code
cli+code
sti+code
switchvm+code
idtinit+code
trap+code
wakeup+code
driver

The IO APIC has a table and the processor can program entries in the table through memory-mapped I/O. During initialization, xv6 programs to map interrupt 0 to IRQ 0, and so on, but disables them all. Specific devices enable particular interrupts and say to which processor the interrupt should be routed. For example, xv6 routes keyboard interrupts to processor 0 (8274). Xv6 routes disk interrupts to the highest numbered processor on the system, as we will see below.

The timer chip is inside the LAPIC, so that each processor can receive timer interrupts independently. Xv6 sets it up in `lapicinit` (7408). The key line is the one that programs the timer (7421). This line tells the LAPIC to periodically generate an interrupt at IRQ_TIMER, which is IRQ 0. Line (7451) enables interrupts on a CPU's LAPIC, which will cause it to deliver interrupts to the local processor.

A processor can control if it wants to receive interrupts through the IF flag in the `%eflags` register. The instruction `cli` disables interrupts on the processor by clearing IF, and `sti` enables interrupts on a processor. Xv6 disables interrupts during booting of the main cpu (9112) and the other processors (1124). The scheduler on each processor enables interrupts (2766). To control that certain code fragments are not interrupted, xv6 disables interrupts during these code fragments (e.g., see `switchvm` (1860)).

The timer interrupts through vector 32 (which xv6 chose to handle IRQ 0), which xv6 setup in `idtinit` (1255). The only difference between vector 32 and vector 64 (the one for system calls) is that vector 32 is an interrupt gate instead of a trap gate. Interrupt gates clear IF, so that the interrupted processor doesn't receive interrupts while it is handling the current interrupt. From here on until `trap`, interrupts follow the same code path as system calls and exceptions, building up a trap frame.

Trap when it's called for a time interrupt, does just two things: increment the `ticks` variable (3417), and call `wakeup`. The latter, as we will see in Chapter 5, may cause the interrupt to return in a different process.

Drivers

A driver is the code in an operating system that manages a particular device: it tells the device hardware to perform operations, configures the device to generate interrupts when done, and handles the resulting interrupts. Driver code can be tricky to write because a driver executes concurrently with the device that it manages. In addition, the driver must understand the device's interface (e.g., which I/O ports do what), and that interface can be complex and poorly documented.

The disk driver provides a good example. The disk driver copies data from and

back to the disk. Disk hardware traditionally presents the data on the disk as a numbered sequence of 512-byte *blocks* (also called *sectors*): sector 0 is the first 512 bytes, sector 1 is the next, and so on. The block size that an operating system uses for its file system maybe different than the sector size that a disk uses, but typically the block size is a multiple of the sector size. Xv6's block size is identical to the disk's sector size. To represent a block xv6 has a structure `struct buf` (3850). The data stored in this structure is often out of sync with the disk: it might have not yet been read in from disk (the disk is working on it but hasn't returned the sector's content yet), or it might have been updated but not yet written out. The driver must ensure that the rest of xv6 doesn't get confused when the structure is out of sync with the disk.

block
sector
struct buf+code
B_VALID+code
B_DIRTY+code
ideinit+code
main+code
ioapicenable+code
IDE_IRQ+code
ideinit+code
idewait+code
IDE_BSY+code
IDE_DRDY+code
iderw+code
B_DIRTY+code
B_VALID+code
iderw+code

Code: Disk driver

The IDE device provides access to disks connected to the PC standard IDE controller. IDE is now falling out of fashion in favor of SCSI and SATA, but the interface is simple and lets us concentrate on the overall structure of a driver instead of the details of a particular piece of hardware.

Xv6 represent file system blocks using `struct buf` (3850). `BSIZE` (4055) is identical to the IDE's sector size and thus each buffer represents the contents of one sector on a particular disk device. The `dev` and `sector` fields give the device and sector number and the `data` field is an in-memory copy of the disk sector. Although the xv6 file system chooses `BSIZE` to be identical to the IDE's sector size, the driver can handle a `BSIZE` that is a multiple of the sector size. Operating systems often use bigger blocks than 512 bytes to obtain higher disk throughput.

The `flags` track the relationship between memory and disk: the `B_VALID` flag means that data has been read in, and the `B_DIRTY` flag means that data needs to be written out.

The kernel initializes the disk driver at boot time by calling `ideinit` (4251) from `main` (1232). `ideinit` calls `ioapicenable` to enable the `IDE_IRQ` interrupt (4256). The call to `ioapicenable` enables the interrupt only on the last CPU (`ncpu-1`): on a two-processor system, CPU 1 handles disk interrupts.

Next, `ideinit` probes the disk hardware. It begins by calling `idewait` (4257) to wait for the disk to be able to accept commands. A PC motherboard presents the status bits of the disk hardware on I/O port `0x1f7`. `idewait` (4238) polls the status bits until the busy bit (`IDE_BSY`) is clear and the ready bit (`IDE_DRDY`) is set.

Now that the disk controller is ready, `ideinit` can check how many disks are present. It assumes that disk 0 is present, because the boot loader and the kernel were both loaded from disk 0, but it must check for disk 1. It writes to I/O port `0x1f6` to select disk 1 and then waits a while for the status bit to show that the disk is ready (4259-4266). If not, `ideinit` assumes the disk is absent.

After `ideinit`, the disk is not used again until the buffer cache calls `iderw`, which updates a locked buffer as indicated by the flags. If `B_DIRTY` is set, `iderw` writes the buffer to the disk; if `B_VALID` is not set, `iderw` reads the buffer from the disk.

Disk accesses typically take milliseconds, a long time for a processor. The boot

loader issues disk read commands and reads the status bits repeatedly until the data is ready (see Appendix B). This `polling` or `busy waiting` is fine in a boot loader, which has nothing better to do. In an operating system, however, it is more efficient to let another process run on the CPU and arrange to receive an interrupt when the disk operation has completed. `Iderw` takes this latter approach, keeping the list of pending disk requests in a queue and using interrupts to find out when each request has finished. Although `iderw` maintains a queue of requests, the simple IDE disk controller can only handle one operation at a time. The disk driver maintains the invariant that it has sent the buffer at the front of the queue to the disk hardware; the others are simply waiting their turn.

`polling`
`busy waiting`
`iderw+code`
`idestart+code`
`idestart+code`
`iderw+code`
`trap+code`
`ideintr+code`
`insl+code`
`B_VALID+code`
`B_DIRTY+code`
`batch`

`Iderw` (4354) adds the buffer `b` to the end of the queue (4367-4371). If the buffer is at the front of the queue, `iderw` must send it to the disk hardware by calling `idestart` (4326-4328); otherwise the buffer will be started once the buffers ahead of it are taken care of.

`Idestart` (4274) issues either a read or a write for the buffer's device and sector, according to the flags. If the operation is a write, `idestart` must supply the data now (4296) and the interrupt will signal that the data has been written to disk. If the operation is a read, the interrupt will signal that the data is ready, and the handler will read it. Note that `idestart` has detailed knowledge about the IDE device, and writes the right values at the right ports. If any of these `outb` statements is wrong, the IDE will do something differently than what we want. Getting these details right is one reason why writing device drivers is challenging.

Having added the request to the queue and started it if necessary, `iderw` must wait for the result. As discussed above, `polling` does not make efficient use of the CPU. Instead, `iderw` sleeps, waiting for the interrupt handler to record in the buffer's flags that the operation is done (4378-4379). While this process is sleeping, `xv6` will schedule other processes to keep the CPU busy.

Eventually, the disk will finish its operation and trigger an interrupt. `trap` will call `ideintr` to handle it (3424). `Ideintr` (4304) consults the first buffer in the queue to find out which operation was happening. If the buffer was being read and the disk controller has data waiting, `ideintr` reads the data into the buffer with `insl` (4317-4319). Now the buffer is ready: `ideintr` sets `B_VALID`, clears `B_DIRTY`, and wakes up any process sleeping on the buffer (4321-4324). Finally, `ideintr` must pass the next waiting buffer to the disk (4326-4328).

Real world

Supporting all the devices on a PC motherboard in its full glory is much work, because there are many devices, the devices have many features, and the protocol between device and driver can be complex. In many operating systems, the drivers together account for more code in the operating system than the core kernel.

Actual device drivers are far more complex than the disk driver in this chapter, but the basic ideas are the same: typically devices are slower than CPU, so the hardware uses interrupts to notify the operating system of status changes. Modern disk controllers typically accept a batch of disk requests at a time and even reorder them

to make most efficient use of the disk arm. When disks were simpler, operating system often reordered the request queue themselves.

Many operating systems have drivers for solid-state disks because they provide much faster access to data. But, although a solid-state works very differently from a traditional mechanical disk, both devices provide block-based interfaces and reading/writing blocks on a solid-state disk is still more expensive than reading/writing RAM.

Other hardware is surprisingly similar to disks: network device buffers hold packets, audio device buffers hold sound samples, graphics card buffers hold video data and command sequences. High-bandwidth devices—disks, graphics cards, and network cards—often use direct memory access (DMA) instead of the explicit I/O (`insl`, `outsl`) in this driver. DMA allows the disk or other controllers direct access to physical memory. The driver gives the device the physical address of the buffer's data field and the device copies directly to or from main memory, interrupting once the copy is complete. Using DMA means that the CPU is not involved at all in the transfer, which can be more efficient and is less taxing for the CPU's memory caches.

Some drivers dynamically switch between polling and interrupts, because using interrupts can be expensive, but using polling can introduce delay until the driver processes an event. For example, for a network driver that receives a burst of packets, may switch from interrupts to polling since it knows that more packets must be processed and it is less expensive to process them using polling. Once no more packets need to be processed, the driver may switch back to interrupts, so that it will be alerted immediately when a new packet arrives.

The IDE driver routed interrupts statically to a particular processor. Some drivers have a sophisticated algorithm for routing interrupts to processor so that the load of processing packets is well balanced but good locality is achieved too. For example, a network driver might arrange to deliver interrupts for packets of one network connection to the processor that is managing that connection, while interrupts for packets of another connection are delivered to another processor. This routing can get quite sophisticated; for example, if some network connections are short lived while others are long lived and the operating system wants to keep all processors busy to achieve high throughput.

If user process reads a file, the data for that file is copied twice. First, it is copied from the disk to kernel memory by the driver, and then later it is copied from kernel space to user space by the read system call. If the user process, then sends the data on the network, then the data is copied again twice: once from user space to kernel space and from kernel space to the network device. To support applications for which low latency is important (e.g., a Web serving static Web pages), operating systems use special code paths to avoid these many copies. As one example, in real-world operating systems, buffers typically match the hardware page size, so that read-only copies can be mapped into a process's address space using the paging hardware, without any copying.

Exercises

1. Set a breakpoint at the first instruction of `syscall()` to catch the very first system call (e.g., `br syscall`). What values are on the stack at this point? Explain the output of `x/37x $esp` at that breakpoint with each value labeled as to what it is (e.g., saved `%ebp` for trap, `trapframe.eip`, scratch space, etc.).
2. Add a new system call to get the current UTC time and return it to the user program. You may want to use the helper function, `cmostime()` (defined in `lapic.c`), to read the real time clock. The file `date.h` contains the definition of the struct `rtdate` struct, which you will provide as an argument to `cmostime()` as a pointer.
3. Write a driver for a disk that supports the SATA standard (search for SATA on the Web). Unlike IDE, SATA isn't obsolete. Use SATA's tagged command queuing to issue many commands to the disk so that the disk internally can reorder commands to obtain high performance.
4. Add simple driver for an Ethernet card.

Chapter 4

Locking

Xv6 runs on multiprocessors: computers with multiple CPUs executing independently. These multiple CPUs share physical RAM, and xv6 exploits the sharing to maintain data structures that all CPUs read and write. This sharing raises the possibility of one CPU reading a data structure while another CPU is mid-way through updating it, or even multiple CPUs updating the same data simultaneously; without careful design such parallel access is likely to yield incorrect results or a broken data structure. Even on a uniprocessor, an interrupt routine that uses the same data as some interruptible code could damage the data if the interrupt occurs at just the wrong time.

Any code that accesses shared data concurrently must have a strategy for maintaining correctness despite concurrency. The concurrency may arise from accesses by multiple cores, or by multiple threads, or by interrupt code. xv6 uses a handful of simple concurrency control strategies; much more sophistication is possible. This chapter focuses on one of the strategies used extensively in xv6 and many other systems: the `lock`.

A lock provides mutual exclusion, ensuring that only one CPU at a time can hold the lock. If a lock is associated with each shared data item, and the code always holds the associated lock when using a given item, then we can be sure that the item is used from only one CPU at a time. In this situation, we say that the lock protects the data item.

The rest of this chapter explains why xv6 needs locks, how xv6 implements them, and how it uses them. A key observation will be that if you look at some code in xv6, you must ask yourself if another processor (or interrupt) could change the intended behavior of the code by modifying data (or hardware resources) it depends on. You must keep in mind that a single C statement can be several machine instructions and thus another processor or an interrupt may muck around in the middle of a C statement. You cannot assume that lines of code on the page are executed atomically. Concurrency makes reasoning about correctness much more difficult.

Race conditions

As an example of why we need locks, consider several processors sharing a single disk, such as the IDE disk in xv6. The disk driver maintains a linked list of the outstanding disk requests (4226) and processors may add new requests to the list concurrently (4354). If there were no concurrent requests, you might implement the linked list as follows:

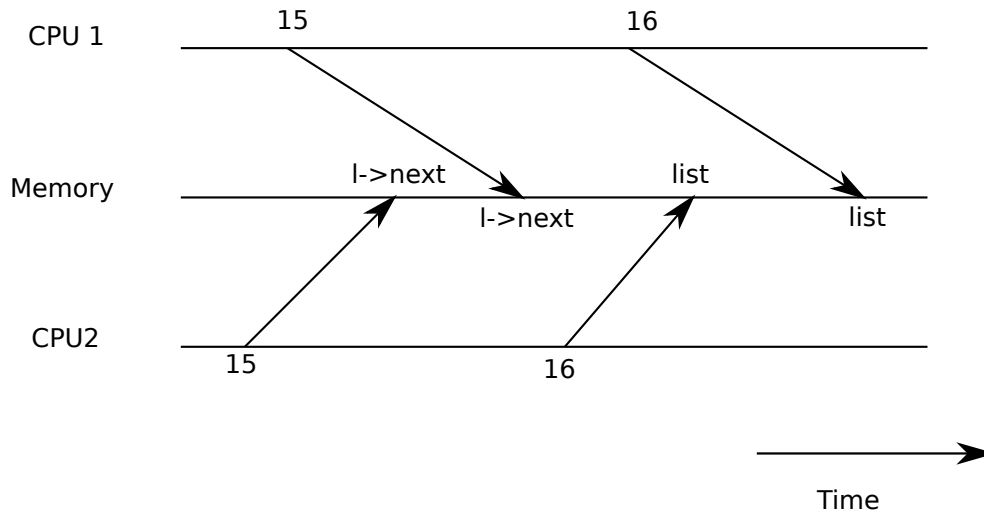

Figure 4-1. Example race

```

1  struct list {
2      int data;
3      struct list *next;
4  };
5
6  struct list *list = 0;
7
8  void
9  insert(int data)
10 {
11     struct list *l;
12
13     l = malloc(sizeof *l);
14     l->data = data;
15     l->next = list;
16     list = l;
17 }

```

race condition

This implementation is correct if executed in isolation. However, the code is not correct if more than one copy executes concurrently. If two CPUs execute `insert` at the same time, it could happen that both execute line 15 before either executes 16 (see Figure 4-1). If this happens, there will now be two list nodes with `next` set to the former value of `list`. When the two assignments to `list` happen at line 16, the second one will overwrite the first; the node involved in the first assignment will be lost.

The lost update at line 16 is an example of a race condition. A race condition is a situation in which a memory location is accessed concurrently, and at least one access is a write. A race is often a sign of a bug, either a lost update (if the accesses are writes) or a read of an incompletely-updated data structure. The outcome of a race depends on the exact timing of the two CPUs involved and how their memory operations are ordered by the memory system, which can make race-induced errors difficult to reproduce and debug. For example, adding print statements while debugging in-

sert might change the timing of the execution enough to make the race disappear.

The usual way to avoid races is to use a lock. Locks ensure mutual exclusion, so that only one CPU can execute insert at a time; this makes the scenario above impossible. The correctly locked version of the above code adds just a few lines (not numbered):

mutual exclusion
critical section
serializing
struct
spinlock+code

```
6   struct list *list = 0;
   struct lock listlock;
7
8   void
9   insert(int data)
10  {
11     struct list *l;
12
13     acquire(&listlock);
14     l = malloc(sizeof *l);
15     l->data = data;
16     l->next = list;
17     list = l;
   release(&listlock);
}
```

The sequence of instructions between acquire and release is often called a critical section, and the lock protects list.

When we say that a lock protects data, we really mean that the lock protects some collection of invariants that apply to the data. Invariants are properties of data structures that are maintained across operations. Typically, an operation's correct behavior depends on the invariants being true when the operation begins. The operation may temporarily violate the invariants but must reestablish them before finishing. For example, in the linked list case, the invariant is that list points at the first node in the list and that each node's next field points at the next node. The implementation of insert violates this invariant temporarily: line 13 creates a new list element l with the intent that l be the first node in the list, but l's next pointer does not point at the next node in the list yet (reestablished at line 15) and list does not point at l yet (reestablished at line 16). The race condition we examined above happened because a second CPU executed code that depended on the list invariants while they were (temporarily) violated. Proper use of a lock ensures that only one CPU at a time can operate on the data structure in the critical section, so that no CPU will execute a data structure operation when the data structure's invariants do not hold.

You can think of locks as serializing concurrent critical sections so that they run one at a time, and thus preserve invariants (assuming they are correct in isolation). You can also think of critical sections as being atomic with respect to each other, so that a critical section that obtains the lock later sees only the complete set of changes from earlier critical sections, and never sees partially-completed updates.

Code: Locks

Xv6 has two types of locks: spin-locks and sleep-locks. We'll start with spin-locks. Xv6 represents a spin-lock as a struct spinlock (1501). The important field in the

structure is locked, a word that is zero when the lock is available and non-zero when it is held. Logically, xv6 should acquire a lock by executing code like

```
21 void
22 acquire(struct spinlock *lk)
23 {
24     for(;;) {
25         if(!lk->locked) {
26             lk->locked = 1;
27             break;
28         }
29     }
30 }
```

acquire+code
atomic
xchg+code
acquire+code
release+code
iderw+code

Unfortunately, this implementation does not guarantee mutual exclusion on a multi-processor. It could happen that two CPUs simultaneously reach line 25, see that `lk->locked` is zero, and then both grab the lock by executing line 26. At this point, two different CPUs hold the lock, which violates the mutual exclusion property. Rather than helping us avoid race conditions, this implementation of `acquire` has its own race condition. The problem here is that lines 25 and 26 executed as separate actions. In order for the routine above to be correct, lines 25 and 26 must execute in one atomic (i.e., indivisible) step.

To execute those two lines atomically, xv6 relies on a special x86 instruction, `xchg` (0569). In one atomic operation, `xchg` swaps a word in memory with the contents of a register. The function `acquire` (1574) repeats this `xchg` instruction in a loop; each iteration atomically reads `lk->locked` and sets it to 1 (1581). If the lock is already held, `lk->locked` will already be 1, so the `xchg` returns 1 and the loop continues. If the `xchg` returns 0, however, `acquire` has successfully acquired the lock—`locked` was 0 and is now 1—so the loop can stop. Once the lock is acquired, `acquire` records, for debugging, the CPU and stack trace that acquired the lock. If a process forgets to release a lock, this information can help to identify the culprit. These debugging fields are protected by the lock and must only be edited while holding the lock.

The function `release` (1602) is the opposite of `acquire`: it clears the debugging fields and then releases the lock. The function uses an assembly instruction to clear `locked`, because clearing this field should be atomic so that the `xchg` instruction won't see a subset of the 4 bytes that hold `locked` updated. The x86 guarantees that a 32-bit `movl` updates all 4 bytes atomically. Xv6 cannot use a regular C assignment, because the C language specification does not specify that a single assignment is atomic.

Xv6's implementation of spin-locks is x86-specific, and xv6 is thus not directly portable to other processors. To allow for portable implementations of spin-locks, the C language supports a library of atomic instructions; a portable operating system would use those instructions.

Code: Using locks

Xv6 uses locks in many places to avoid race conditions. A simple example is in the IDE driver (4200). As mentioned in the beginning of the chapter, `iderw` (4354) has a queue of disk requests and processors may add new requests to the list concurrently

(4369). To protect this list and other invariants in the driver, `iderw` acquires the `ide-lock` (4365) and releases it at the end of the function. idelock+code

Exercise 1 explores how to trigger the IDE driver race condition that we saw at the beginning of the chapter by moving the `acquire` to after the queue manipulation. It is worthwhile to try the exercise because it will make clear that it is not that easy to trigger the race, suggesting that it is difficult to find race-conditions bugs. It is not unlikely that xv6 has some races.

A hard part about using locks is deciding how many locks to use and which data and invariants each lock protects. There are a few basic principles. First, any time a variable can be written by one CPU at the same time that another CPU can read or write it, a lock should be introduced to keep the two operations from overlapping. Second, remember that locks protect invariants: if an invariant involves multiple memory locations, typically all of them need to be protected by a single lock to ensure the invariant is maintained.

The rules above say when locks are necessary but say nothing about when locks are unnecessary, and it is important for efficiency not to lock too much, because locks reduce parallelism. If parallelism isn't important, then one could arrange to have only a single thread and not worry about locks. A simple kernel can do this on a multiprocessor by having a single lock that must be acquired on entering the kernel and released on exiting the kernel (though system calls such as pipe reads or `wait` would pose a problem). Many uniprocessor operating systems have been converted to run on multiprocessors using this approach, sometimes called a "giant kernel lock," but the approach sacrifices parallelism: only one CPU can execute in the kernel at a time. If the kernel does any heavy computation, it would be more efficient to use a larger set of more fine-grained locks, so that the kernel could execute on multiple CPUs simultaneously.

Ultimately, the choice of lock granularity is an exercise in parallel programming. Xv6 uses a few coarse data-structure specific locks (see Figure 4-2). For example, xv6 has a lock that protects the whole process table and its invariants, which are described in Chapter 5. A more fine-grained approach would be to have a lock per entry in the process table so that threads working on different entries in the process table can proceed in parallel. However, it complicates operations that have invariants over the whole process table, since they might have to acquire several locks. Subsequent chapters will discuss how each part of xv6 deals with concurrency, illustrating how to use locks.

Deadlock and lock ordering

If a code path through the kernel must hold several locks at the same time, it is important that all code paths acquire the locks in the same order. If they don't, there is a risk of deadlock. Let's say two code paths in xv6 need locks A and B, but code path 1 acquires locks in the order A then B, and the other path acquires them in the order B then A. This situation can result in a deadlock if two threads execute the code paths concurrently. Suppose thread T1 executes code path 1 and acquires lock A, and thread T2 executes code path 2 and acquires lock B. Next T1 will try to acquire lock B, and

Lock	Description
<code>bcache.lock</code>	Protects allocation of block buffer cache entries
<code>cons.lock</code>	Serializes access to console hardware, avoids intermixed output
<code>ftable.lock</code>	Serializes allocation of a struct file in file table
<code>icache.lock</code>	Protects allocation of inode cache entries
<code>idelock</code>	Serializes access to disk hardware and disk queue
<code>kmem.lock</code>	Serializes allocation of memory
<code>log.lock</code>	Serializes operations on the transaction log
<code>pipe's p->lock</code>	Serializes operations on each pipe
<code>ptable.lock</code>	Serializes context switching, and operations on <code>proc->state</code> and <code>proctable</code>
<code>tickslock</code>	Serializes operations on the ticks counter
<code>inode's ip->lock</code>	Serializes operations on each inode and its content
<code>buf's b->lock</code>	Serializes operations on each block buffer

Figure 4-2. Locks in xv6

T2 will try to acquire lock A. Both acquires will block indefinitely, because in both cases the other thread holds the needed lock, and won't release it until its acquire returns. To avoid such deadlocks, all code paths must acquire locks in the same order. The need for a global lock acquisition order means that locks are effectively part of each function's specification: callers must invoke functions in a way that causes locks to be acquired in the agreed-on order.

Xv6 has many lock-order chains of length two involving the `ptable.lock`, due to the way that `sleep` works as discussed in Chapter 5. For example, `ideintr` holds the `ide` lock while calling `wakeup`, which acquires the `ptable` lock. The file system code contains xv6's longest lock chains. For example, creating a file requires simultaneously holding a lock on the directory, a lock on the new file's inode, a lock on a disk block buffer, `idelock`, and `ptable.lock`. To avoid deadlock, file system code always acquires locks in the order mentioned in the previous sentence.

`ideintr+code`
`wakeup+code`
`ptable+code`
`ticks+code`
`sys_sleep+code`
`tickslock+code`
`iderw+code`
`idelock+code`
`ideintr+code`

Interrupt handlers

Xv6 uses spin-locks in many situations to protect data that is used by both interrupt handlers and threads. For example, a timer interrupt might (3414) increment `ticks` at about the same time that a kernel thread reads `ticks` in `sys_sleep` (3823). The lock `tickslock` serializes the two accesses.

Interrupts can cause concurrency even on a single processor: if interrupts are enabled, kernel code can be stopped at any moment to run an interrupt handler instead. Suppose `iderw` held the `idelock` and then got interrupted to run `ideintr`. `Ideintr` would try to lock `idelock`, see it was held, and wait for it to be released. In this situation, `idelock` will never be released—only `iderw` can release it, and `iderw` will not continue running until `ideintr` returns—so the processor, and eventually the whole system, will deadlock.

To avoid this situation, if a spin-lock is used by an interrupt handler, a processor must never hold that lock with interrupts enabled. Xv6 is more conservative: when a processor enters a spin-lock critical section, xv6 always ensures interrupts are disabled

on that processor. Interrupts may still occur on other processors, so an interrupt's acquire can wait for a thread to release a spin-lock; just not on the same processor.

xv6 re-enables interrupts when a processor holds no spin-locks; it must do a little book-keeping to cope with nested critical sections. `acquire` calls `pushcli` (1655) and `release` calls `popcli` (1667) to track the nesting level of locks on the current processor. When that count reaches zero, `popcli` restores the interrupt enable state that existed at the start of the outermost critical section. The `cli` and `sti` functions execute the x86 interrupt disable and enable instructions, respectively.

It is important that `acquire` call `pushcli` before the `xchg` that might acquire the lock (1581). If the two were reversed, there would be a few instruction cycles when the lock was held with interrupts enabled, and an unfortunately timed interrupt would deadlock the system. Similarly, it is important that `release` call `popcli` only after the `xchg` that releases the lock (1581).

pushcli+code
popcli+code
acquire+code
xchg+code
release+code
popcli+code
xchg+code

Instruction and memory ordering

This chapter has assumed that code executes in the order in which the code appears in the program. Many compilers and processors, however, execute code out of order to achieve higher performance. If an instruction takes many cycles to complete, a processor may want to issue the instruction early so that it can overlap with other instructions and avoid processor stalls. For example, a processor may notice that in a serial sequence of instructions A and B are not dependent on each other and start instruction B before A so that it will be completed when the processor completes A. A compiler may perform a similar re-ordering by emitting instruction B before instruction A in the executable file. Concurrency, however, may expose this reordering to software, which can lead to incorrect behavior.

For example, in this code for `insert`, it would be a disaster if the compiler or processor caused the effects of line 4 (or 3 or 5) to be visible to other cores after the effects of line 6:

```
1   acquire(&listlock);
2   l = malloc(sizeof *l);
3   l->data = data;
4   l->next = list;
5   list = l;
6   release(&listlock);
```

To tell the hardware and compiler not to perform such re-orderings, xv6 uses `__sync_synchronize()`, in both `acquire` and `release`. `__sync_synchronize()` is a memory barrier: it tells the compiler and CPU to not reorder loads or stores across the barrier. Xv6 worries about ordering only in `acquire` and `release`, because concurrent access to data structures other than the lock structure is performed between `acquire` and `release`.

Sleep locks

Sometimes xv6 code needs to hold a lock for a long time. For example, the file

system (Chapter 6) keeps a file locked while reading and writing its content on the disk, and these disk operations can take tens of milliseconds. Efficiency demands that the processor be yielded while waiting so that other threads can make progress, and this in turn means that xv6 needs locks that work well when held across context switches. Xv6 provides such locks in the form of `sleep-locks`.

Xv6 sleep-locks support yielding the processor during their critical sections. This property poses a design challenge: if thread T1 holds lock L1 and has yielded the processor, and thread T2 wishes to acquire L1, we have to ensure that T1 can execute while T2 is waiting so that T1 can release L1. T2 can't use the spin-lock acquire function here: it spins with interrupts turned off, and that would prevent T1 from running. To avoid this deadlock, the sleep-lock acquire routine (called `acquiresleep`) yields the processor while waiting, and does not disable interrupts.

`acquiresleep` (4622) uses techniques that will be explained in Chapter 5. At a high level, a sleep-lock has a `locked` field that is protected by a spinlock, and `acquiresleep`'s call to `sleep` atomically yields the CPU and releases the spin-lock. The result is that other threads can execute while `acquiresleep` waits.

Because sleep-locks leave interrupts enabled, they cannot be used in interrupt handlers. Because `acquiresleep` may yield the processor, sleep-locks cannot be used inside spin-lock critical sections (though spin-locks can be used inside sleep-lock critical sections).

Xv6 uses spin-locks in most situations, since they have low overhead. It uses sleep-locks only in the file system, where it is convenient to be able to hold locks across lengthy disk operations.

Limitations of locks

Locks often solve concurrency problems cleanly, but there are times when they are awkward. Subsequent chapters will point out such situations in xv6; this section outlines some of the problems that come up.

Sometimes a function uses data which must be guarded by a lock, but the function is called both from code that already holds the lock and from code that wouldn't otherwise need the lock. One way to deal with this is to have two variants of the function, one that acquires the lock, and the other that expects the caller to already hold the lock; see `wakeup1` for an example (2953). Another approach is for the function to require callers to hold the lock whether the caller needs it or not, as with `sched` (2758). Kernel developers need to be aware of such requirements.

It might seem that one could simplify situations where both caller and callee need a lock by allowing recursive locks, so that if a function holds a lock, any function it calls is allowed to re-acquire the lock. However, the programmer would then need to reason about all combinations of caller and callee, because it will no longer be the case that the data structure's invariants always hold after an acquire. Whether recursive locks are better than xv6's use of conventions about functions that require a lock to be held is not clear. The larger lesson is that (as with global lock ordering to avoid deadlock) lock requirements sometimes can't be private, but intrude themselves on the interfaces of functions and modules.

A situation in which locks are insufficient is when one thread needs to wait for another thread's update to a data structure, for example when a pipe's reader waits for some other thread to write the pipe. The waiting thread cannot hold the lock on the data, since that would prevent the update it is waiting for. Instead, xv6 provides a separate mechanism that jointly manages the lock and event wait; see the description of `sleep` and `wakeup` in Chapter 5.

Real world

Concurrency primitives and parallel programming are active areas of research, because programming with locks is still challenging. It is best to use locks as the base for higher-level constructs like synchronized queues, although xv6 does not do this. If you program with locks, it is wise to use a tool that attempts to identify race conditions, because it is easy to miss an invariant that requires a lock.

Most operating systems support POSIX threads (Pthreads), which allow a user process to have several threads running concurrently on different processors. Pthreads has support for user-level locks, barriers, etc. Supporting Pthreads requires support from the operating system. For example, it should be the case that if one pthread blocks in a system call, another pthread of the same process should be able to run on that processor. As another example, if a pthread changes its process's address space (e.g., grow or shrink it), the kernel must arrange that other processors that run threads of the same process update their hardware page tables to reflect the change in the address space. On the x86, this involves shooting down the Translation Look-aside Buffer (TLB) of other processors using inter-processor interrupts (IPIs).

It is possible to implement locks without atomic instructions, but it is expensive, and most operating systems use atomic instructions.

Locks can be expensive if many processors try to acquire the same lock at the same time. If one processor has a lock cached in its local cache, and another processor must acquire the lock, then the atomic instruction to update the cache line that holds the lock must move the line from the one processor's cache to the other processor's cache, and perhaps invalidate any other copies of the cache line. Fetching a cache line from another processor's cache can be orders of magnitude more expensive than fetching a line from a local cache.

To avoid the expenses associated with locks, many operating systems use lock-free data structures and algorithms. For example, it is possible to implement a linked list like the one in the beginning of the chapter that requires no locks during list searches, and one atomic instruction to insert an item in a list. Lock-free programming is more complicated, however, than programming locks; for example, one must worry about instruction and memory reordering. Programming with locks is already hard, so xv6 avoids the additional complexity of lock-free programming.

Exercises

1. Write a parallel program using POSIX threads, which is supported on most operating systems. For example, implement a parallel hash table and measure if the num-

ber of puts/gets scales with increasing number of cores.

2. Remove the xchg in acquire. Explain what happens when you run xv6?

3. Move the acquire in iderw to before sleep. Is there a race? Why don't you observe it when booting xv6 and run stressfs? Increase critical section with a dummy loop; what do you see now? explain.

4. Implement a subset of Pthreads in xv6. That is, implement a user-level thread library so that a user process can have more than 1 thread and arrange that these threads can run in parallel on different processors. Come up with a design that correctly handles a thread making a blocking system call and changing its shared address space.

Chapter 5

Scheduling

Any operating system is likely to run with more processes than the computer has processors, and so a plan is needed to time-share the processors among the processes. Ideally the sharing would be transparent to user processes. A common approach is to provide each process with the illusion that it has its own virtual processor by multiplexing the processes onto the hardware processors. This chapter explains how xv6 achieves this multiplexing.

Multiplexing

Xv6 multiplexes by switching each processor from one process to another in two situations. First, xv6's `sleep` and `wakeup` mechanism switches when a process waits for device or pipe I/O to complete, or waits for a child to exit, or waits in the `sleep` system call. Second, xv6 periodically forces a switch when a process is executing user instructions. This multiplexing creates the illusion that each process has its own CPU, just as xv6 uses the memory allocator and hardware page tables to create the illusion that each process has its own memory.

Implementing multiplexing poses a few challenges. First, how to switch from one process to another? Xv6 uses the standard mechanism of context switching; although the idea is simple, the implementation is some of the most opaque code in the system. Second, how to do context switching transparently? Xv6 uses the standard technique of using the timer interrupt handler to drive context switches. Third, many CPUs may be switching among processes concurrently, and a locking plan is necessary to avoid races. Fourth, when a process has exited its memory and other resources must be freed, but it cannot do all of this itself because (for example) it can't free its own kernel stack while still using it. Finally, on a multiprocessor, each processor may run a process and when a processor switches from one process to another, the core must know which process it is running so that it can save the state of the currently-running process in the correct `proc` structure. Xv6 tries to solve these problems as simply as possible, but nevertheless the resulting code is tricky.

xv6 must provide ways for processes to coordinate among themselves. For example, a parent process may need to wait for one of its children to exit, or a process reading a pipe may need to wait for some other process to write the pipe. Rather than make the waiting process waste CPU by repeatedly checking whether the desired event has happened, xv6 allows a process to give up the CPU and sleep waiting for an event, and allows another process to wake the first process up. Care is needed to avoid races that result in the loss of event notifications. As an example of these problems and their solution, this chapter examines the implementation of pipes.

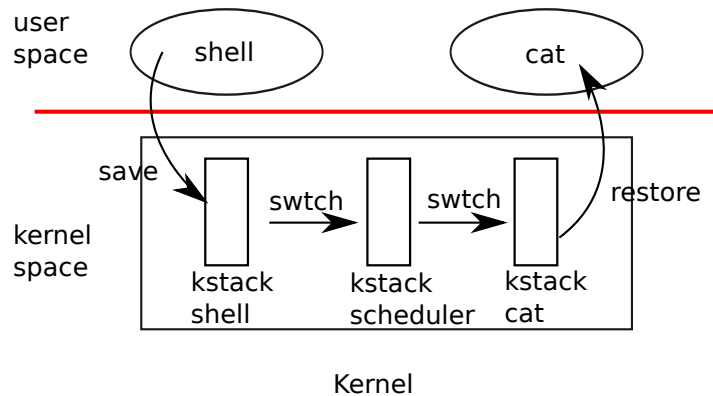

Figure 5-1. Switching from one user process to another. In this example, xv6 runs with one CPU (and thus one scheduler thread).

Code: Context switching

Figure 5-1 outlines the steps involved in switching from one user process to another: a user-kernel transition (system call or interrupt) to the old process’s kernel thread, a context switch to the local CPU’s scheduler thread, a context switch to a new process’s kernel thread, and a trap return to the user-level process. Xv6 uses two context switches because the scheduler runs on its own stack in order to simplify cleaning up user processes, as we will see when discussing the code for `exit` and `kill`. In this section we’ll examine the mechanics of switching between a kernel thread and a scheduler thread.

Every xv6 process has its own kernel stack and register set, as we saw in Chapter 2. Each CPU has a separate scheduler thread for use when it is executing the scheduler rather than any process’s kernel thread. Switching from one thread to another involves saving the old thread’s CPU registers, and restoring the previously-saved registers of the new thread; the fact that `%esp` and `%eip` are saved and restored means that the CPU will switch stacks and switch what code it is executing.

`swtch` doesn’t directly know about threads; it just saves and restores register sets, called contexts. When it is time for a process to give up the CPU, the process’s kernel thread calls `swtch` to save its own context and return to the scheduler context. Each context is represented by a `struct context*`, a pointer to a structure stored on the kernel stack involved. `Swtch` takes two arguments: `struct context **old` and `struct context *new`. It pushes the current CPU register onto the stack and saves the stack pointer in `*old`. Then `swtch` copies `new` to `%esp`, pops previously saved registers, and returns.

Let’s follow the initial user process through `swtch` into the scheduler. We saw in Chapter 3 that one possibility at the end of each interrupt is that `trap` calls `yield`. `Yield` in turn calls `sched`, which calls `swtch` to save the current context in `proc->context` and switch to the scheduler context previously saved in `cpu->scheduler` (2822).

`Swtch` (3052) starts by copying its arguments from the stack to the caller-saved registers `%eax` and `%edx` (3059-3060); `swtch` must do this before it changes the stack pointer

```
swtch+code
contexts
struct context+code
trap+code
yield+code
sched+code
swtch+code
cpu-
>scheduler+code
swtch+code
```

and can no longer access the arguments via `%esp`. Then `swtch` pushes the register state, creating a context structure on the current stack. Only the callee-saved registers need to be saved; the convention on the x86 is that these are `%ebp`, `%ebx`, `%esi`, `%edi`, and `%esp`. `Swtch` pushes the first four explicitly (3063-3066); it saves the last implicitly as the `struct context*` written to `*old` (3069). There is one more important register: the program counter `%eip`. It has already been saved on the stack by the `call` instruction that invoked `swtch`. Having saved the old context, `swtch` is ready to restore the new one. It moves the pointer to the new context into the stack pointer (3070). The new stack has the same form as the old one that `swtch` just left—the new stack *was* the old one in a previous call to `swtch`—so `swtch` can invert the sequence to restore the new context. It pops the values for `%edi`, `%esi`, `%ebx`, and `%ebp` and then returns (3073-3077). Because `swtch` has changed the stack pointer, the values restored and the instruction address returned to are the ones from the new context.

In our example, `sched` called `swtch` to switch to `cpu->scheduler`, the per-CPU scheduler context. That context had been saved by `scheduler`'s call to `swtch` (2781). When the `swtch` we have been tracing returns, it returns not to `sched` but to `scheduler`, and its stack pointer points at the current CPU's scheduler stack, not `initproc`'s kernel stack.

```
swtch+code
sched+code
swtch+code
cpu-
>scheduler+code
swtch+code
scheduler+code
swtch+code
ptable.lock+code
sched+code
sleep+code
exit+code
sched+code
swtch+code
cpu-
>scheduler+code
scheduler+code
ptable.lock+code
swtch+code
ptable.lock+code
swtch+code
yield+code
```

Code: Scheduling

The last section looked at the low-level details of `swtch`; now let's take `swtch` as a given and examine the conventions involved in switching from process to scheduler and back to process. A process that wants to give up the CPU must acquire the process table lock `ptable.lock`, release any other locks it is holding, update its own state (`proc->state`), and then call `sched`. `Yield` (2828) follows this convention, as do `sleep` and `exit`, which we will examine later. `Sched` double-checks those conditions (2813-2818) and then an implication of those conditions: since a lock is held, the CPU should be running with interrupts disabled. Finally, `sched` calls `swtch` to save the current context in `proc->context` and switch to the scheduler context in `cpu->scheduler`. `Swtch` returns on the scheduler's stack as though `scheduler`'s `swtch` had returned (2781). The scheduler continues the `for` loop, finds a process to run, switches to it, and the cycle repeats.

We just saw that `xv6` holds `ptable.lock` across calls to `swtch`: the caller of `swtch` must already hold the lock, and control of the lock passes to the switched-to code. This convention is unusual with locks; usually the thread that acquires a lock is also responsible for releasing the lock, which makes it easier to reason about correctness. For context switching it is necessary to break this convention because `ptable.lock` protects invariants on the process's state and `context` fields that are not true while executing in `swtch`. One example of a problem that could arise if `ptable.lock` were not held during `swtch`: a different CPU might decide to run the process after `yield` had set its state to `RUNNABLE`, but before `swtch` caused it to stop using its own kernel stack. The result would be two CPUs running on the same stack, which cannot be right.

A kernel thread always gives up its processor in `sched` and always switches to the

same location in the scheduler, which (almost) always switches to some kernel thread that previously called `sched`. Thus, if one were to print out the line numbers where `xv6` switches threads, one would observe the following simple pattern: (2781), (2822), (2781), (2822), and so on. The procedures in which this stylized switching between two threads happens are sometimes referred to as *coroutines*; in this example, `sched` and `scheduler` are co-routines of each other.

There is one case when the scheduler's call to `swtch` does not end up in `sched`. We saw this case in Chapter 2: when a new process is first scheduled, it begins at `forkret` (2853). `Forkret` exists to release the `ptable.lock`; otherwise, the new process could start at `trapret`.

`Scheduler` (2758) runs a simple loop: find a process to run, run it until it stops, repeat. `scheduler` holds `ptable.lock` for most of its actions, but releases the lock (and explicitly enables interrupts) once in each iteration of its outer loop. This is important for the special case in which this CPU is idle (can find no `RUNNABLE` process). If an idling scheduler looped with the lock continuously held, no other CPU that was running a process could ever perform a context switch or any process-related system call, and in particular could never mark a process as `RUNNABLE` so as to break the idling CPU out of its scheduling loop. The reason to enable interrupts periodically on an idling CPU is that there might be no `RUNNABLE` process because processes (e.g., the shell) are waiting for I/O; if the scheduler left interrupts disabled all the time, the I/O would never arrive.

The scheduler loops over the process table looking for a runnable process, one that has `p->state == RUNNABLE`. Once it finds a process, it sets the per-CPU current process variable `proc`, switches to the process's page table with `switchvm`, marks the process as `RUNNING`, and then calls `swtch` to start running it (2774-2781).

One way to think about the structure of the scheduling code is that it arranges to enforce a set of invariants about each process, and holds `ptable.lock` whenever those invariants are not true. One invariant is that if a process is `RUNNING`, a timer interrupt's `yield` must be able to switch away from the process; this means that the CPU registers must hold the process's register values (i.e. they aren't actually in a context), `%cr3` must refer to the process's pagetable, `%esp` must refer to the process's kernel stack so that `swtch` can push registers correctly, and `proc` must refer to the process's `proc[]` slot. Another invariant is that if a process is `RUNNABLE`, an idle CPU's `scheduler` must be able to run it; this means that `p->context` must hold the process's kernel thread variables, that no CPU is executing on the process's kernel stack, that no CPU's `%cr3` refers to the process's page table, and that no CPU's `proc` refers to the process.

Maintaining the above invariants is the reason why `xv6` acquires `ptable.lock` in one thread (often in `yield`) and releases the lock in a different thread (the scheduler thread or another next kernel thread). Once the code has started to modify a running process's state to make it `RUNNABLE`, it must hold the lock until it has finished restoring the invariants: the earliest correct release point is after `scheduler` stops using the process's page table and clears `proc`. Similarly, once `scheduler` starts to convert a runnable process to `RUNNING`, the lock cannot be released until the kernel thread is completely running (after the `swtch`, e.g. in `yield`).

`ptable.lock` protects other things as well: allocation of process IDs and free

coroutines
sched+code
scheduler+code
swtch+code
sched+code
forkret+code
ptable.lock+code
scheduler+code
ptable.lock+code
RUNNABLE+code
switchvm+code
swtch+code
ptable.lock+code
yield+code
RUNNABLE+code
scheduler+code
p->context+code
ptable.lock+code
ptable.lock+code

process table slots, the interplay between `exit` and `wait`, the machinery to avoid lost wakeups (see next section), and probably other things too. It might be worth thinking about whether the different functions of `ptable.lock` could be split up, certainly for clarity and perhaps for performance.

`exit+code`
`wait+code`
`struct cpu+code`
`mycpu+code`
`lapicid+code`
`myproc+code`
`sequence`
`coordination`
`conditional`
`synchronization`

Code: mycpu and myproc

In many places in xv6, a processor must identify which process it is running. For example, when a processor serves a `yield` system call, the processor must determine which process is invoking `yield`. Xv6 follows the standard plan that relies on a tiny bit of hardware support. Xv6 maintains an array of `struct cpu` (2301). The array has one entry for each processor and each entry contains per-processor state, such as the current-running process, as well as a hardware identifier for that processor (`apicid`). When a processor must find its per-cpu state, it reads its identifier from its local APIC and uses that identifier to find its state in the array.

The kernel uses the function `mycpu` (2437) to find its `apicid`, which in turn calls the function `lapicid`. The function `lapicid` returns the hardware identifier for this processor and `mycpu` uses that identifier to find its `struct cpu`. These functions are invoked by a kernel thread and there is risk that the kernel thread may be scheduled to a different processor after reading the `apicid` but before `mycpu` returns. If that happens the function returns the wrong `apicid`. To avoid this problem, xv6 requires that callers of `mycpu` invoke it with interrupts disabled.

The kernel uses the function `myproc` (2457) to find the `struct proc` for the process that is running on the current processor. The function `myproc` disables interrupts, and invokes `mycpu` to find its processor's state, which contains a field `proc`. When a processor switches to a new process in `scheduler`, it sets `proc` to that process's `struct proc`.

The function `mycpu` scans the CPU array to find the `struct cpu` with the matching `apicid`. This scan is inefficient and kernels in the real-world often dedicate a CPU register to cache a pointer to the current processor's state.

Sleep and wakeup

Scheduling and locks help conceal the existence of one process from another, but so far we have no abstractions that help processes intentionally interact. Sleep and wakeup fill that void, allowing one process to sleep waiting for an event and another process to wake it up once the event has happened. Sleep and wakeup are often called `sequence coordination` or `conditional synchronization` mechanisms, and there are many other similar mechanisms in the operating systems literature.

To illustrate what we mean, let's consider a simple producer/consumer queue. This queue is similar to the one that feeds commands from processes to the IDE driver (see Chapter 3), but abstracts away all IDE-specific code. The queue allows one process to send a nonzero pointer to another process. If there were only one sender and one receiver, and they executed on different CPUs, and the compiler didn't optimize too aggressively, this implementation would be correct:

```

100     struct q {
101         void *ptr;
102     };
103
104     void*
105     send(struct q *q, void *p)
106     {
107         while(q->ptr != 0)
108             ;
109         q->ptr = p;
110     }
111
112     void*
113     recv(struct q *q)
114     {
115         void *p;
116
117         while((p = q->ptr) == 0)
118             ;
119         q->ptr = 0;
120         return p;
121     }

```

busy waiting
 polling
 sleep+code
 wakeup+code
 chan+code
 wait channel

Send loops until the queue is empty (`ptr == 0`) and then puts the pointer `p` in the queue. Recv loops until the queue is non-empty and takes the pointer out. When run in different processes, `send` and `recv` both modify `q->ptr`, but `send` only writes the pointer when it is zero and `recv` only writes the pointer when it is nonzero, so no updates are lost.

The implementation above is expensive. If the sender sends rarely, the receiver will spend most of its time spinning in the `while` loop hoping for a pointer. The receiver's CPU could find more productive work than busy waiting by repeatedly polling `q->ptr`. Avoiding busy waiting requires a way for the receiver to yield the CPU and resume only when `send` delivers a pointer.

Let's imagine a pair of calls, `sleep` and `wakeup`, that work as follows. `Sleep(chan)` sleeps on the arbitrary value `chan`, called the wait channel. `Sleep` puts the calling process to sleep, releasing the CPU for other work. `Wakeup(chan)` wakes all processes sleeping on `chan` (if any), causing their `sleep` calls to return. If no processes are waiting on `chan`, `wakeup` does nothing. We can change the queue implementation to use `sleep` and `wakeup`:

```

201     void*
202     send(struct q *q, void *p)
203     {
204         while(q->ptr != 0)
205             ;
206         q->ptr = p;
207         wakeup(q); /* wake recv */
208     }
209
210     void*
211     recv(struct q *q)
212     {

```

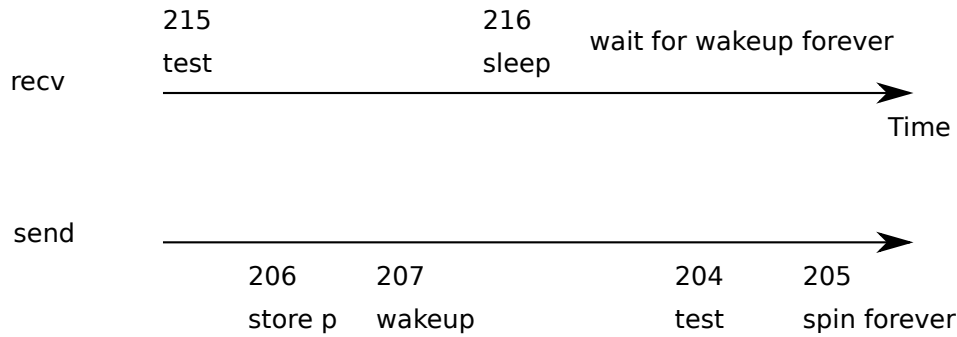

Figure 5-2. Example lost wakeup problem

```

213     void *p;
214
215     while((p = q->ptr) == 0)
216         sleep(q);
217     q->ptr = 0;
218     return p;
219 }

```

deadlocked

Recv now gives up the CPU instead of spinning, which is nice. However, it turns out not to be straightforward to design `sleep` and `wakeup` with this interface without suffering from what is known as the “lost wake-up” problem (see Figure 5-2). Suppose that `recv` finds that `q->ptr == 0` on line 215. While `recv` is between lines 215 and 216, `send` runs on another CPU: it changes `q->ptr` to be nonzero and calls `wakeup`, which finds no processes sleeping and thus does nothing. Now `recv` continues executing at line 216: it calls `sleep` and goes to sleep. This causes a problem: `recv` is asleep waiting for a pointer that has already arrived. The next `send` will wait for `recv` to consume the pointer in the queue, at which point the system will be deadlocked.

The root of this problem is that the invariant that `recv` only sleeps when `q->ptr == 0` is violated by `send` running at just the wrong moment. One incorrect way of protecting the invariant would be to modify the code for `recv` as follows:

```

300     struct q {
301         struct spinlock lock;
302         void *ptr;
303     };
304
305     void*
306     send(struct q *q, void *p)
307     {
308         acquire(&q->lock);
309         while(q->ptr != 0)
310             ;
311         q->ptr = p;
312         wakeup(q);
313         release(&q->lock);
314     }
315
316     void*

```

```

317     recv(struct q *q)                                sleep+code
318     {
319         void *p;
320
321         acquire(&q->lock);
322         while((p = q->ptr) == 0)
323             sleep(q);
324         q->ptr = 0;
325         release(&q->lock);
326         return p;
327     }

```

One might hope that this version of `recv` would avoid the lost wakeup because the lock prevents `send` from executing between lines 322 and 323. It does that, but it also deadlocks: `recv` holds the lock while it sleeps, so the sender will block forever waiting for the lock.

We'll fix the preceding scheme by changing `sleep`'s interface: the caller must pass the lock to `sleep` so it can release the lock after the calling process is marked as asleep and waiting on the sleep channel. The lock will force a concurrent `send` to wait until the receiver has finished putting itself to sleep, so that the wakeup will find the sleeping receiver and wake it up. Once the receiver is awake again `sleep` reacquires the lock before returning. Our new correct scheme is useable as follows:

```

400     struct q {
401         struct spinlock lock;
402         void *ptr;
403     };
404
405     void*
406     send(struct q *q, void *p)
407     {
408         acquire(&q->lock);
409         while(q->ptr != 0)
410             ;
411         q->ptr = p;
412         wakeup(q);
413         release(&q->lock);
414     }
415
416     void*
417     recv(struct q *q)
418     {
419         void *p;
420
421         acquire(&q->lock);
422         while((p = q->ptr) == 0)
423             sleep(q, &q->lock);
424         q->ptr = 0;
425         release(&q->lock);
426         return p;
427     }

```

The fact that `recv` holds `q->lock` prevents `send` from trying to wake it up between `recv`'s check of `q->ptr` and its call to `sleep`. We need `sleep` to atomically re-

lease `q->lock` and put the receiving process to sleep.

A complete sender/receiver implementation would also sleep in `send` when waiting for a receiver to consume the value from a previous `send`.

sleep+code
wakeup+code
SLEEPING+code
sched+code
RUNNABLE+code
ptable.lock+code
wakeup+code
ptable.lock+code
ptable.lock+code
wakeup1+code
wakeup+code
SLEEPING+code
chan+code
RUNNABLE+code

Code: Sleep and wakeup

Let's look at the implementation of `sleep` (2874) and `wakeup` (2953). The basic idea is to have `sleep` mark the current process as `SLEEPING` and then call `sched` to release the processor; `wakeup` looks for a process sleeping on the given wait channel and marks it as `RUNNABLE`. Callers of `sleep` and `wakeup` can use any mutually convenient number as the channel. Xv6 often uses the address of a kernel data structure involved in the waiting.

`Sleep` (2874) begins with a few sanity checks: there must be a current process (2878) and `sleep` must have been passed a lock (2881-2882). Then `sleep` acquires `ptable.lock` (2891). Now the process going to sleep holds both `ptable.lock` and `lk`. Holding `lk` was necessary in the caller (in the example, `recv`): it ensured that no other process (in the example, one running `send`) could start a call to `wakeup(chan)`. Now that `sleep` holds `ptable.lock`, it is safe to release `lk`: some other process may start a call to `wakeup(chan)`, but `wakeup` will not run until it can acquire `ptable.lock`, so it must wait until `sleep` has finished putting the process to sleep, keeping the `wakeup` from missing the `sleep`.

There is a minor complication: if `lk` is equal to `&ptable.lock`, then `sleep` would deadlock trying to acquire it as `&ptable.lock` and then release it as `lk`. In this case, `sleep` considers the acquire and release to cancel each other out and skips them entirely (2890). For example, `wait` (2964) calls `sleep` with `&ptable.lock`.

Now that `sleep` holds `ptable.lock` and no others, it can put the process to sleep by recording the sleep channel, changing the process state, and calling `sched` (2895-2898).

At some point later, a process will call `wakeup(chan)`. `Wakeup` (2964) acquires `ptable.lock` and calls `wakeup1`, which does the real work. It is important that `wakeup` hold the `ptable.lock` both because it is manipulating process states and because, as we just saw, `ptable.lock` makes sure that `sleep` and `wakeup` do not miss each other. `Wakeup1` is a separate function because sometimes the scheduler needs to execute a `wakeup` when it already holds the `ptable.lock`; we will see an example of this later. `Wakeup1` (2953) loops over the process table. When it finds a process in state `SLEEPING` with a matching `chan`, it changes that process's state to `RUNNABLE`. The next time the scheduler runs, it will see that the process is ready to be run.

Xv6 code always calls `wakeup` while holding the lock that guards the sleep condition; in the example above that lock is `q->lock`. Strictly speaking it is sufficient if `wakeup` always follows the acquire (that is, one could call `wakeup` after the release). Why do the locking rules for `sleep` and `wakeup` ensure a sleeping process won't miss a `wakeup` it needs? The sleeping process holds either the lock on the condition or the `ptable.lock` or both from a point before it checks the condition to a point after it is marked as sleeping. If a concurrent thread causes the condition to be true, that thread must either hold the lock on the condition before the sleeping thread acquired it, or after the sleeping thread released it in `sleep`. If before, the sleeping thread must have

seen the new condition value, and decided to sleep anyway, so it doesn't matter if it misses the wakeup. If after, then the earliest the waker could acquire the lock on the condition is after `sleep` acquires `ptable.lock`, so that `wakeup`'s acquisition of `ptable.lock` must wait until `sleep` has completely finished putting the sleeper to sleep. Then `wakeup` will see the sleeping process and wake it up (unless something else wakes it up first).

It is sometimes the case that multiple processes are sleeping on the same channel; for example, more than one process reading from a pipe. A single call to `wakeup` will wake them all up. One of them will run first and acquire the lock that `sleep` was called with, and (in the case of pipes) read whatever data is waiting in the pipe. The other processes will find that, despite being woken up, there is no data to be read. From their point of view the `wakeup` was "spurious," and they must sleep again. For this reason `sleep` is always called inside a loop that checks the condition.

No harm is done if two uses of `sleep/wakeup` accidentally choose the same channel: they will see spurious wakeups, but looping as described above will tolerate this problem. Much of the charm of `sleep/wakeup` is that it is both lightweight (no need to create special data structures to act as sleep channels) and provides a layer of indirection (callers need not know which specific process they are interacting with).

Code: Pipes

The simple queue we used earlier in this chapter was a toy, but `xv6` contains two real queues that use `sleep` and `wakeup` to synchronize readers and writers. One is in the IDE driver: a process adds a disk request to a queue and then calls `sleep`. The IDE interrupt handler uses `wakeup` to alert the process that its request has completed.

A more complex example is the implementation of pipes. We saw the interface for pipes in Chapter 0: bytes written to one end of a pipe are copied in an in-kernel buffer and then can be read out of the other end of the pipe. Future chapters will examine the file descriptor support surrounding pipes, but let's look now at the implementations of `pipewrite` and `piperead`.

Each pipe is represented by a `struct pipe`, which contains a `lock` and a data buffer. The fields `nread` and `nwrite` count the number of bytes read from and written to the buffer. The buffer wraps around: the next byte written after `buf[PIPESIZE-1]` is `buf[0]`. The counts do not wrap. This convention lets the implementation distinguish a full buffer (`nwrite == nread+PIPESIZE`) from an empty buffer (`nwrite == nread`), but it means that indexing into the buffer must use `buf[nread % PIPESIZE]` instead of just `buf[nread]` (and similarly for `nwrite`). Let's suppose that calls to `piperead` and `pipewrite` happen simultaneously on two different CPUs.

`Pipewrite` (6830) begins by acquiring the pipe's lock, which protects the counts, the data, and their associated invariants. `Piperead` (6851) then tries to acquire the lock too, but cannot. It spins in `acquire` (1574) waiting for the lock. While `piperead` waits, `pipewrite` loops over the bytes being written—`addr[0]`, `addr[1]`, ..., `addr[n-1]`—adding each to the pipe in turn (6844). During this loop, it could happen that the buffer fills (6836). In this case, `pipewrite` calls `wakeup` to alert any sleeping readers to the fact that there is data waiting in the buffer and then sleeps on `&p->nwrite` to wait

for a reader to take some bytes out of the buffer. Sleep releases `p->lock` as part of putting `pipewrite`'s process to sleep.

`RUNNABLE+code`
`wait+code`
`ZOMBIE+code`
`struct proc+code`
`exit+code`
`sched+code`

Now that `p->lock` is available, `piperead` manages to acquire it and enters its critical section: it finds that `p->nread != p->nwrite` (6856) (`pipewrite` went to sleep because `p->nwrite == p->nread+PIPE_SIZE` (6836)) so it falls through to the for loop, copies data out of the pipe (6863-6867), and increments `nread` by the number of bytes copied. That many bytes are now available for writing, so `piperead` calls `wakeup` (6868) to wake any sleeping writers before it returns to its caller. `Wakeup` finds a process sleeping on `&p->nwrite`, the process that was running `pipewrite` but stopped when the buffer filled. It marks that process as `RUNNABLE`.

The pipe code uses separate sleep channels for reader and writer (`p->nread` and `p->nwrite`); this might make the system more efficient in the unlikely event that there are lots of readers and writers waiting for the same pipe. The pipe code sleeps inside a loop checking the sleep condition; if there are multiple readers or writers, all but the first process to wake up will see the condition is still false and sleep again.

Code: Wait, exit, and kill

Sleep and wakeup can be used for many kinds of waiting. An interesting example, seen in Chapter 0, is the `wait` system call that a parent process uses to wait for a child to exit. When a child exits, it does not die immediately. Instead, it switches to the `ZOMBIE` process state until the parent calls `wait` to learn of the exit. The parent is then responsible for freeing the memory associated with the process and preparing the `struct proc` for reuse. If the parent exits before the child, the `init` process adopts the child and waits for it, so that every child has a parent to clean up after it.

An implementation challenge is the possibility of races between parent and child `wait` and `exit`, as well as `exit` and `exit`. `wait` begins by acquiring `ptable.lock`. Then it scans the process table looking for children. If `wait` finds that the current process has children but that none have exited, it calls `sleep` to wait for one of them to exit (2707) and scans again. Here, the lock being released in `sleep` is `ptable.lock`, the special case we saw above.

`Exit` acquires `ptable.lock` and then wakes up any process sleeping on a wait channel equal to the current process's parent `proc` (2651); if there is such a process, it will be the parent in `wait`. This may look premature, since `exit` has not marked the current process as a `ZOMBIE` yet, but it is safe: although `wakeup` may mark the parent as `RUNNABLE`, the loop in `wait` cannot run until `exit` releases `ptable.lock` by calling `sched` to enter the scheduler, so `wait` can't look at the exiting process until after `exit` has set its state to `ZOMBIE` (2663). Before `exit` reschedules, it reparents all of the exiting process's children, passing them to the `initproc` (2653-2660). Finally, `exit` calls `sched` to relinquish the CPU.

If the parent process was sleeping in `wait`, the scheduler will eventually run it. The call to `sleep` returns holding `ptable.lock`; `wait` rescans the process table and finds the exited child with `state == ZOMBIE`. (2657). It records the child's `pid` and then cleans up the `struct proc`, freeing the memory associated with the process (2687-2694).

The child process could have done most of the cleanup during `exit`, but it is im-

portant that the parent process be the one to free `p->kstack` and `p->pgdir`: when the child runs `exit`, its stack sits in the memory allocated as `p->kstack` and it uses its own pagetable. They can only be freed after the child process has finished running for the last time by calling `swtch` (via `sched`). This is one reason that the scheduler procedure runs on its own stack rather than on the stack of the thread that called `sched`.

`p->kstack+code`
`p->pgdir+code`
`swtch+code`
round robin
priority inversion
convoys

While `exit` allows a process to terminate itself, `kill` (2975) lets one process request that another be terminated. It would be too complex for `kill` to directly destroy the victim process, since the victim might be executing on another CPU or sleeping while midway through updating kernel data structures. To address these challenges, `kill` does very little: it just sets the victim's `p->killed` and, if it is sleeping, wakes it up. Eventually the victim will enter or leave the kernel, at which point code in `trap` will call `exit` if `p->killed` is set. If the victim is running in user space, it will soon enter the kernel by making a system call or because the timer (or some other device) interrupts.

If the victim process is in `sleep`, the call to `wakeup` will cause the victim process to return from `sleep`. This is potentially dangerous because the condition being waiting for may not be true. However, xv6 calls to `sleep` are always wrapped in a `while` loop that re-tests the condition after `sleep` returns. Some calls to `sleep` also test `p->killed` in the loop, and abandon the current activity if it is set. This is only done when such abandonment would be correct. For example, the pipe read and write code (6837) returns if the killed flag is set; eventually the code will return back to `trap`, which will again check the flag and `exit`.

Some xv6 `sleep` loops do not check `p->killed` because the code is in the middle of a multi-step system call that should be atomic. The IDE driver (4379) is an example: it does not check `p->killed` because a disk operation may be one of a set of writes that are all needed in order for the file system to be left in a correct state. To avoid the complication of cleaning up after a partial operation, xv6 delays the killing of a process that is in the IDE driver until some point later when it is easy to kill the process (e.g., when the complete file system operation has completed and the process is about to return to user space).

Real world

The xv6 scheduler implements a simple scheduling policy, which runs each process in turn. This policy is called round robin. Real operating systems implement more sophisticated policies that, for example, allow processes to have priorities. The idea is that a runnable high-priority process will be preferred by the scheduler over a runnable low-priority thread. These policies can become complex quickly because there are often competing goals: for example, the operating might also want to guarantee fairness and high-throughput. In addition, complex policies may lead to unintended interactions such as priority inversion and convoys. Priority inversion can happen when a low-priority and high-priority process share a lock, which when acquired by the low-priority process can cause the high-priority process to not run. A long convoy can form when many high-priority processes are waiting for a low-priority process that acquires a shared lock; once a convoy has formed they can persist for

long period of time. To avoid these kinds of problems additional mechanisms are necessary in sophisticated schedulers.

Sleep and wakeup are a simple and effective synchronization method, but there are many others. The first challenge in all of them is to avoid the “lost wakeups” problem we saw at the beginning of the chapter. The original Unix kernel’s `sleep` simply disabled interrupts, which sufficed because Unix ran on a single-CPU system. Because `xv6` runs on multiprocessors, it adds an explicit lock to `sleep`. FreeBSD’s `msleep` takes the same approach. Plan 9’s `sleep` uses a callback function that runs with the scheduling lock held just before going to sleep; the function serves as a last minute check of the sleep condition, to avoid lost wakeups. The Linux kernel’s `sleep` uses an explicit process queue instead of a wait channel; the queue has its own internal lock.

Scanning the entire process list in wakeup for processes with a matching chan is inefficient. A better solution is to replace the chan in both `sleep` and wakeup with a data structure that holds a list of processes sleeping on that structure. Plan 9’s `sleep` and wakeup call that structure a rendezvous point or `Rendez`. Many thread libraries refer to the same structure as a condition variable; in that context, the operations `sleep` and wakeup are called `wait` and `signal`. All of these mechanisms share the same flavor: the sleep condition is protected by some kind of lock dropped atomically during sleep.

The implementation of wakeup wakes up all processes that are waiting on a particular channel, and it might be the case that many processes are waiting for that particular channel. The operating system will schedule all these processes and they will race to check the sleep condition. Processes that behave in this way are sometimes called a `thundering herd`, and it is best avoided. Most condition variables have two primitives for wakeup: `signal`, which wakes up one process, and `broadcast`, which wakes up all processes waiting.

Semaphores are another common coordination mechanism. A semaphore is an integer value with two operations, increment and decrement (or up and down). It is always possible to increment a semaphore, but the semaphore value is not allowed to drop below zero: a decrement of a zero semaphore sleeps until another process increments the semaphore, and then those two operations cancel out. The integer value typically corresponds to a real count, such as the number of bytes available in a pipe buffer or the number of zombie children that a process has. Using an explicit count as part of the abstraction avoids the “lost wakeup” problem: there is an explicit count of the number of wakeups that have occurred. The count also avoids the spurious wakeup and thundering herd problems.

Terminating processes and cleaning them up introduces much complexity in `xv6`. In most operating systems it is even more complex, because, for example, the victim process may be deep inside the kernel sleeping, and unwinding its stack requires much careful programming. Many operating system unwind the stack using explicit mechanisms for exception handling, such as `longjmp`. Furthermore, there are other events that can cause a sleeping process to be woken up, even though the events it is waiting for has not happened yet. For example, when a Unix process is sleeping, another process may send a `signal` to it. In this case, the process will return from the interrupted system call with the value `-1` and with the error code set to `EINTR`. The application

can check for these values and decide what to do. Xv6 doesn't support signals and this complexity doesn't arise.

Xv6's support for `kill` is not entirely satisfactory: there are `sleep` loops which probably should check for `p->killed`. A related problem is that, even for `sleep` loops that check `p->killed`, there is a race between `sleep` and `kill`; the latter may set `p->killed` and try to wake up the victim just after the victim's loop checks `p->killed` but before it calls `sleep`. If this problem occurs, the victim won't notice the `p->killed` until the condition it is waiting for occurs. This may be quite a bit later (e.g., when the IDE driver returns a disk block that the victim is waiting for) or never (e.g., if the victim is waiting from input from the console, but the user doesn't type any input).

Exercises

1. `sleep` has to check `lk != &ptable.lock` to avoid a deadlock (2890-2893). It could eliminate the special case by replacing

```
if(lk != &ptable.lock){
    acquire(&ptable.lock);
    release(lk);
}
```

with

```
release(lk);
acquire(&ptable.lock);
```

Doing this would break `sleep`. How?

2. Most process cleanup could be done by either `exit` or `wait`, but we saw above that `exit` must not free `p->stack`. It turns out that `exit` must be the one to close the open files. Why? The answer involves pipes.

3. Implement semaphores in `xv6`. You can use mutexes but do not use `sleep` and `wakeup`. Replace the uses of `sleep` and `wakeup` in `xv6` with semaphores. Judge the result.

4. Fix the race mentioned above between `kill` and `sleep`, so that a `kill` that occurs after the victim's `sleep` loop checks `p->killed` but before it calls `sleep` results in the victim abandoning the current system call.

5. Design a plan so that every `sleep` loop checks `p->killed` so that, for example, a process that is in the IDE driver can return quickly from the while loop if another kills that process.

6. Design a plan that uses only one context switch when switching from one user process to another. This plan involves running the scheduler procedure on the kernel stack of the user process, instead of the dedicated scheduler stack. The main challenge is to clean up a user process correctly. Measure the performance benefit of avoiding one context switch.

7. The lock `p->lock` protects many invariants, and when looking at a particular piece of `xv6` code that is protected by `p->lock`, it can be difficult to figure out which invariant is being enforced. Design a plan that is more clean by perhaps splitting `p-`

>lock in several locks.

Chapter 6

File system

The purpose of a file system is to organize and store data. File systems typically support sharing of data among users and applications, as well as persistence so that data is still available after a reboot.

The xv6 file system provides Unix-like files, directories, and pathnames (see Chapter 0), and stores its data on an IDE disk for persistence (see Chapter 3). The file system addresses several challenges:

- The file system needs on-disk data structures to represent the tree of named directories and files, to record the identities of the blocks that hold each file's content, and to record which areas of the disk are free.
- The file system must support crash recovery. That is, if a crash (e.g., power failure) occurs, the file system must still work correctly after a restart. The risk is that a crash might interrupt a sequence of updates and leave inconsistent on-disk data structures (e.g., a block that is both used in a file and marked free).
- Different processes may operate on the file system at the same time, so the file system code must coordinate to maintain invariants.
- Accessing a disk is orders of magnitude slower than accessing memory, so the file system must maintain an in-memory cache of popular blocks.

The rest of this chapter explains how xv6 addresses these challenges.

Overview

The xv6 file system implementation is organized in seven layers, shown in Figure 6-1. The disk layer reads and writes blocks on an IDE hard drive. The buffer cache layer caches disk blocks and synchronizes access to them, making sure that only one kernel process at a time can modify the data stored in any particular block. The logging layer allows higher layers to wrap updates to several blocks in a transaction, and ensures that the blocks are updated atomically in the face of crashes (i.e., all of them are updated or none). The inode layer provides individual files, each represented as an `inode` with a unique `i-number` and some blocks holding the file's data. The directory layer implements each directory as a special kind of inode whose content is a sequence of directory entries, each of which contains a file's name and `i-number`. The pathname layer provides hierarchical path names like `/usr/rtm/xv6/fs.c`, and resolves them with recursive lookup. The file descriptor layer abstracts many Unix resources (e.g., pipes, devices, files, etc.) using the file system interface, simplifying the lives of application programmers.

The file system must have a plan for where it stores inodes and content blocks on the disk. To do so, xv6 divides the disk into several sections, as shown in Figure 6-2. The file system does not use block 0 (it holds the boot sector). Block 1 is called the

File descriptor
Pathname
Directory
Inode
Logging
Buffer cache
Disk

Figure 6-1. Layers of the xv6 file system.

superblock; it contains metadata about the file system (the file system size in blocks, the number of data blocks, the number of inodes, and the number of blocks in the log). Blocks starting at 2 hold the log. After the log are the inodes, with multiple inodes per block. After those come bitmap blocks tracking which data blocks are in use. The remaining blocks are data blocks; each is either marked free in the bitmap block, or holds content for a file or directory. The superblock is filled in by a separate program, called `mfs`, which builds an initial file system.

superblock
`mfs+code`
`bread+code`
`bwrite+code`
`buf`
`brelease+code`

The rest of this chapter discusses each layer, starting with the buffer cache. Look out for situations where well-chosen abstractions at lower layers ease the design of higher ones.

Buffer cache layer

The buffer cache has two jobs: (1) synchronize access to disk blocks to ensure that only one copy of a block is in memory and that only one kernel thread at a time uses that copy; (2) cache popular blocks so that they don't need to be re-read from the slow disk. The code is in `bio.c`.

The main interface exported by the buffer cache consists of `bread` and `bwrite`; the former obtains a `buf` containing a copy of a block which can be read or modified in memory, and the latter writes a modified buffer to the appropriate block on the disk. A kernel thread must release a buffer by calling `brelease` when it is done with it. The buffer cache uses a per-buffer sleep-lock to ensure that only one thread at a time uses each buffer (and thus each disk block); `bread` returns a locked buffer, and `brelease` releases the lock.

Let's return to the buffer cache. The buffer cache has a fixed number of buffers to hold disk blocks, which means that if the file system asks for a block that is not already in the cache, the buffer cache must recycle a buffer currently holding some other block. The buffer cache recycles the least recently used buffer for the new block. The assumption is that the least recently used buffer is the one least likely to be used again

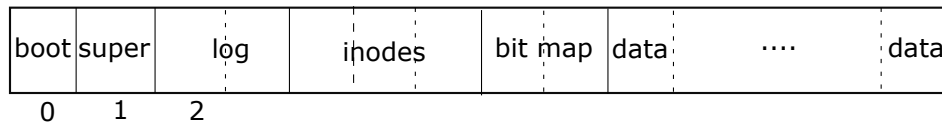

Figure 6-2. Structure of the xv6 file system. The header `fs.h` (4050) contains constants and data structures describing the exact layout of the file system.

soon.

Code: Buffer cache

The buffer cache is a doubly-linked list of buffers. The function `binit`, called by `main` (1230), initializes the list with the `NBUF` buffers in the static array `buf` (4450-4459). All other access to the buffer cache refer to the linked list via `bcache.head`, not the `buf` array.

A buffer has two state bits associated with it. `B_VALID` indicates that the buffer contains a copy of the block. `B_DIRTY` indicates that the buffer content has been modified and needs to be written to the disk.

`Bread` (4502) calls `bget` to get a buffer for the given sector (4506). If the buffer needs to be read from disk, `bread` calls `iderw` to do that before returning the buffer.

`Bget` (4466) scans the buffer list for a buffer with the given device and sector numbers (4472-4480). If there is such a buffer, `bget` acquires the sleep-lock for the buffer. `bget` then returns the locked buffer.

If there is no cached buffer for the given sector, `bget` must make one, possibly reusing a buffer that held a different sector. It scans the buffer list a second time, looking for a buffer that is not locked and not dirty: any such buffer can be used. `Bget` edits the buffer metadata to record the new device and sector number and acquires its sleep-lock. Note that the assignment to `flags` clears `B_VALID`, thus ensuring that `bread` will read the block data from disk rather than incorrectly using the buffer's previous contents.

It is important that there is at most one cached buffer per disk sector, to ensure that readers see writes, and because the file system uses locks on buffers for synchronization. `bget` ensures this invariant by holding the `bcache.lock` continuously from the first loop's check of whether the block is cached through the second loop's declaration that the block is now cached (by setting `dev`, `blockno`, and `refcnt`). This causes the check for a block's presence and (if not present) the designation of a buffer to hold the block to be atomic.

It is safe for `bget` to acquire the buffer's sleep-lock outside of the `bcache.lock` critical section, since the non-zero `b->refcnt` prevents the buffer from being re-used for a different disk block. The sleep-lock protects reads and writes of the block's buffered content, while the `bcache.lock` protects information about which blocks are cached.

If all the buffers are busy, then too many processes are simultaneously executing file system calls; `bget` panics. A more graceful response might be to sleep until a

`binit+code`
`main+code`
`NBUF+code`
`bcache.head+code`
`B_VALID+code`
`B_DIRTY+code`
`bget+code`
`iderw+code`
`bget+code`
`bget+code`
`B_VALID+code`

buffer became free, though there would then be a possibility of deadlock.

Once `bread` has read the disk (if needed) and returned the buffer to its caller, the caller has exclusive use of the buffer and can read or write the data bytes. If the caller does modify the buffer, it must call `bwrite` to write the changed data to disk before releasing the buffer. `Bwrite` (4515) calls `iderw` to talk to the disk hardware, after setting `B_DIRTY` to indicate that `iderw` should write (rather than read).

When the caller is done with a buffer, it must call `brelease` to release it. (The name `brelease`, a shortening of `b-release`, is cryptic but worth learning: it originated in Unix and is used in BSD, Linux, and Solaris too.) `Brelease` (4526) releases the sleep-lock and moves the buffer to the front of the linked list (4537-4542). Moving the buffer causes the list to be ordered by how recently the buffers were used (meaning released): the first buffer in the list is the most recently used, and the last is the least recently used. The two loops in `bget` take advantage of this: the scan for an existing buffer must process the entire list in the worst case, but checking the most recently used buffers first (starting at `bcache.head` and following `next` pointers) will reduce scan time when there is good locality of reference. The scan to pick a buffer to reuse picks the least recently used buffer by scanning backward (following `prev` pointers).

`bread+code`
`bwrite+code`
`iderw+code`
`B_DIRTY+code`
`brelease+code`
`log`
`commit`

Logging layer

One of the most interesting problems in file system design is crash recovery. The problem arises because many file system operations involve multiple writes to the disk, and a crash after a subset of the writes may leave the on-disk file system in an inconsistent state. For example, suppose a crash occurs during file truncation (setting the length of a file to zero and freeing its content blocks). Depending on the order of the disk writes, the crash may either leave an inode with a reference to a content block that is marked free, or it may leave an allocated but unreferenced content block.

The latter is relatively benign, but an inode that refers to a freed block is likely to cause serious problems after a reboot. After reboot, the kernel might allocate that block to another file, and now we have two different files pointing unintentionally to the same block. If `xv6` supported multiple users, this situation could be a security problem, since the old file's owner would be able to read and write blocks in the new file, owned by a different user.

`Xv6` solves the problem of crashes during file system operations with a simple form of logging. An `xv6` system call does not directly write the on-disk file system data structures. Instead, it places a description of all the disk writes it wishes to make in a `log` on the disk. Once the system call has logged all of its writes, it writes a special `commit` record to the disk indicating that the log contains a complete operation. At that point the system call copies the writes to the on-disk file system data structures. After those writes have completed, the system call erases the log on disk.

If the system should crash and reboot, the file system code recovers from the crash as follows, before running any processes. If the log is marked as containing a complete operation, then the recovery code copies the writes to where they belong in the on-disk file system. If the log is not marked as containing a complete operation, the recovery code ignores the log. The recovery code finishes by erasing the log.

Why does xv6's log solve the problem of crashes during file system operations? If the crash occurs before the operation commits, then the log on disk will not be marked as complete, the recovery code will ignore it, and the state of the disk will be as if the operation had not even started. If the crash occurs after the operation commits, then recovery will replay all of the operation's writes, perhaps repeating them if the operation had started to write them to the on-disk data structure. In either case, the log makes operations atomic with respect to crashes: after recovery, either all of the operation's writes appear on the disk, or none of them appear.

group commit
batching
write+code
unlink+code

Log design

The log resides at a known fixed location, specified in the superblock. It consists of a header block followed by a sequence of updated block copies ("logged blocks"). The header block contains an array of sector numbers, one for each of the logged blocks. The header block also contains the count of logged blocks. Xv6 writes the header block when a transaction commits, but not before, and sets the count to zero after copying the logged blocks to the file system. Thus a crash midway through a transaction will result in a count of zero in the log's header block; a crash after a commit will result in a non-zero count.

Each system call's code indicates the start and end of the sequence of writes that must be atomic with respect to crashes. To allow concurrent execution of file system operations by different processes, the logging system can accumulate the writes of multiple system calls into one transaction. Thus a single commit may involve the writes of multiple complete system calls. To avoid splitting a system call across transactions, the logging system only commits when no file system system calls are underway.

The idea of committing several transactions together is known as `group commit`. Group commit reduces the number of disk operations because it amortizes the fixed cost of a commit over multiple operations. Group commit also hands the disk system more concurrent writes at the same time, perhaps allowing the disk to write them all during a single disk rotation. Xv6's IDE driver doesn't support this kind of batching, but xv6's file system design allows for it.

Xv6 dedicates a fixed amount of space on the disk to hold the log. The total number of blocks written by the system calls in a transaction must fit in that space. This has two consequences. No single system call can be allowed to write more distinct blocks than there is space in the log. This is not a problem for most system calls, but two of them can potentially write many blocks: `write` and `unlink`. A large file write may write many data blocks and many bitmap blocks as well as an inode block; unlinking a large file might write many bitmap blocks and an inode. Xv6's `write` system call breaks up large writes into multiple smaller writes that fit in the log, and `unlink` doesn't cause problems because in practice the xv6 file system uses only one bitmap block. The other consequence of limited log space is that the logging system cannot allow a system call to start unless it is certain that the system call's writes will fit in the space remaining in the log.

Code: logging

A typical use of the log in a system call looks like this:

```
begin_op();
...
bp = bread(...);
bp->data[...] = ...;
log_write(bp);
...
end_op();
```

```
begin_op+code
log_write+code
bwrite+code
absorption
end_op+code
install_trans+code
recover_from_log+cod
initlog+code
filewrite+code
```

`begin_op` (4828) waits until the logging system is not currently committing, and until there is enough free log space to hold the writes from this call and all currently executing system calls. `log.outstanding` counts that number of calls; the increment both reserves space and prevents a commit from occurring during this system call. The code conservatively assumes that each system call might write up to `MAXOPBLOCKS` distinct blocks.

`log_write` (4922) acts as a proxy for `bwrite`. It records the block's sector number in memory, reserving it a slot in the log on disk, and marks the buffer `B_DIRTY` to prevent the block cache from evicting it. The block must stay in the cache until committed: until then, the cached copy is the only record of the modification; it cannot be written to its place on disk until after commit; and other reads in the same transaction must see the modifications. `log_write` notices when a block is written multiple times during a single transaction, and allocates that block the same slot in the log. This optimization is often called *absorption*. It is common that, for example, the disk block containing inodes of several files is written several times within a transaction. By absorbing several disk writes into one, the file system can save log space and can achieve better performance because only one copy of the disk block must be written to disk.

`end_op` (4853) first decrements the count of outstanding system calls. If the count is now zero, it commits the current transaction by calling `commit()`. There are four stages in this process. `write_log()` (4885) copies each block modified in the transaction from the buffer cache to its slot in the log on disk. `write_head()` (4804) writes the header block to disk: this is the commit point, and a crash after the write will result in recovery replaying the transaction's writes from the log. `install_trans` (4772) reads each block from the log and writes it to the proper place in the file system. Finally `end_op` writes the log header with a count of zero; this has to happen before the next transaction starts writing logged blocks, so that a crash doesn't result in recovery using one transaction's header with the subsequent transaction's logged blocks.

`recover_from_log` (4818) is called from `initlog` (4756), which is called during boot before the first user process runs. (2865) It reads the log header, and mimics the actions of `end_op` if the header indicates that the log contains a committed transaction.

An example use of the log occurs in `filewrite` (6002). The transaction looks like this:

```

begin_op();
iLOCK(f->ip);
r = writei(f->ip, ...);
iunlock(f->ip);
end_op();

```

```

writei+code
balloc+code
bfree+code
inode
struct dinode+code

```

This code is wrapped in a loop that breaks up large writes into individual transactions of just a few sectors at a time, to avoid overflowing the log. The call to `writei` writes many blocks as part of this transaction: the file's inode, one or more bitmap blocks, and some data blocks.

Code: Block allocator

File and directory content is stored in disk blocks, which must be allocated from a free pool. `xv6`'s block allocator maintains a free bitmap on disk, with one bit per block. A zero bit indicates that the corresponding block is free; a one bit indicates that it is in use. The program `mkfs` sets the bits corresponding to the boot sector, superblock, log blocks, inode blocks, and bitmap blocks.

The block allocator provides two functions: `balloc` allocates a new disk block, and `bfree` frees a block. `Balloc` The loop in `balloc` at (5022) considers every block, starting at block 0 up to `sb.size`, the number of blocks in the file system. It looks for a block whose bitmap bit is zero, indicating that it is free. If `balloc` finds such a block, it updates the bitmap and returns the block. For efficiency, the loop is split into two pieces. The outer loop reads each block of bitmap bits. The inner loop checks all BPB bits in a single bitmap block. The race that might occur if two processes try to allocate a block at the same time is prevented by the fact that the buffer cache only lets one process use any one bitmap block at a time.

`Bfree` (5052) finds the right bitmap block and clears the right bit. Again the exclusive use implied by `bread` and `brelease` avoids the need for explicit locking.

As with much of the code described in the remainder of this chapter, `balloc` and `bfree` must be called inside a transaction.

Inode layer

The term `inode` can have one of two related meanings. It might refer to the on-disk data structure containing a file's size and list of data block numbers. Or "inode" might refer to an in-memory inode, which contains a copy of the on-disk inode as well as extra information needed within the kernel.

The on-disk inodes are packed into a contiguous area of disk called the inode blocks. Every inode is the same size, so it is easy, given a number `n`, to find the `n`th inode on the disk. In fact, this number `n`, called the inode number or `i-number`, is how inodes are identified in the implementation.

The on-disk inode is defined by a `struct dinode` (4078). The `type` field distinguishes between files, directories, and special files (devices). A type of zero indicates that an on-disk inode is free. The `nlink` field counts the number of directory entries that refer to this inode, in order to recognize when the on-disk inode and its data

blocks should be freed. The `size` field records the number of bytes of content in the file. The `addrs` array records the block numbers of the disk blocks holding the file's content.

`struct inode+code`
`iget+code`
`iput+code`
`ilock+code`

The kernel keeps the set of active inodes in memory; `struct inode` (4162) is the in-memory copy of a `struct dinode` on disk. The kernel stores an inode in memory only if there are C pointers referring to that inode. The `ref` field counts the number of C pointers referring to the in-memory inode, and the kernel discards the inode from memory if the reference count drops to zero. The `iget` and `iput` functions acquire and release pointers to an inode, modifying the reference count. Pointers to an inode can come from file descriptors, current working directories, and transient kernel code such as `exec`.

There are four lock or lock-like mechanisms in xv6's inode code. `icache.lock` protects the invariant that an inode is present in the cache at most once, and the invariant that a cached inode's `ref` field counts the number of in-memory pointers to the cached inode. Each in-memory inode has a `lock` field containing a sleep-lock, which ensures exclusive access to the inode's fields (such as file length) as well as to the inode's file or directory content blocks. An inode's `ref`, if it is greater than zero, causes the system to maintain the inode in the cache, and not re-use the cache entry for a different inode. Finally, each inode contains a `nlink` field (on disk and copied in memory if it is cached) that counts the number of directory entries that refer to a file; xv6 won't free an inode if its link count is greater than zero.

A `struct inode` pointer returned by `iget()` is guaranteed to be valid until the corresponding call to `iput()`; the inode won't be deleted, and the memory referred to by the pointer won't be re-used for a different inode. `iget()` provides non-exclusive access to an inode, so that there can be many pointers to the same inode. Many parts of the file system code depend on this behavior of `iget()`, both to hold long-term references to inodes (as open files and current directories) and to prevent races while avoiding deadlock in code that manipulates multiple inodes (such as pathname lookup).

The `struct inode` that `iget` returns may not have any useful content. In order to ensure it holds a copy of the on-disk inode, code must call `ilock`. This locks the inode (so that no other process can `ilock` it) and reads the inode from the disk, if it has not already been read. `iunlock` releases the lock on the inode. Separating acquisition of inode pointers from locking helps avoid deadlock in some situations, for example during directory lookup. Multiple processes can hold a C pointer to an inode returned by `iget`, but only one process can lock the inode at a time.

The inode cache only caches inodes to which kernel code or data structures hold C pointers. Its main job is really synchronizing access by multiple processes; caching is secondary. If an inode is used frequently, the buffer cache will probably keep it in memory if it isn't kept by the inode cache. The inode cache is write-through, which means that code that modifies a cached inode must immediately write it to disk with `iupdate`.

Code: Inodes

To allocate a new inode (for example, when creating a file), xv6 calls `ialloc` (5204). `Ialloc` is similar to `ballocc`: it loops over the inode structures on the disk, one block at a time, looking for one that is marked free. When it finds one, it claims it by writing the new `type` to the disk and then returns an entry from the inode cache with the tail call to `iget` (5218). The correct operation of `ialloc` depends on the fact that only one process at a time can be holding a reference to `bp`: `ialloc` can be sure that some other process does not simultaneously see that the inode is available and try to claim it.

`ialloc+code`
`ballocc+code`
`iget+code`
`iget+code`
`ilock+code`
`ilock+code`
`iunlock+code`
`iput+code`
`itrunc+code`
`iput+code`

`Iget` (5254) looks through the inode cache for an active entry (`ip->ref > 0`) with the desired device and inode number. If it finds one, it returns a new reference to that inode. (5263-5267). As `iget` scans, it records the position of the first empty slot (5268-5269), which it uses if it needs to allocate a cache entry.

Code must lock the inode using `ilock` before reading or writing its metadata or content. `Ilock` (5303) uses a sleep-lock for this purpose. Once `ilock` has exclusive access to the inode, it reads the inode from disk (more likely, the buffer cache) if needed. The function `iunlock` (5331) releases the sleep-lock, which may cause any processes sleeping to be woken up.

`Iput` (5358) releases a C pointer to an inode by decrementing the reference count (5376). If this is the last reference, the inode's slot in the inode cache is now free and can be re-used for a different inode.

If `iput` sees that there are no C pointer references to an inode and that the inode has no links to it (occurs in no directory), then the inode and its data blocks must be freed. `Iput` calls `itrunc` to truncate the file to zero bytes, freeing the data blocks; sets the inode `type` to 0 (unallocated); and writes the inode to disk (5353).

The locking protocol in `iput` in the case in which it frees the inode deserves a closer look. One danger is that a concurrent thread might be waiting in `ilock` to use this inode (e.g. to read a file or list a directory), and won't be prepared to find the inode is not longer allocated. This can't happen because there is no way for a system call to get a pointer to a cached inode if it has no links to it and `ip->ref` is one. That one reference is the reference owned by the thread calling `iput`. It's true that `iput` checks that the reference count is one outside of its `icache.lock` critical section, but at that point the link count is known to be zero, so no thread will try to acquire a new reference. The other main danger is that a concurrent call to `ialloc` might choose the same inode that `iput` is freeing. This can only happen after the `iupdate` writes the disk so that the inode has `type` zero. This race is benign; the allocating thread will politely wait to acquire the inode's sleep-lock before reading or writing the inode, at which point `iput` is done with it.

`iput()` can write to the disk. This means that any system call that uses the file system may write the disk, because the system call may be the last one having a reference to the file. Even calls like `read()` that appear to be read-only, may end up calling `iput()`. This, in turn, means that even read-only system calls must be wrapped in transactions if they use the file system.

There is a challenging interaction between `iput()` and crashes. `iput()` doesn't truncate a file immediately when the link count for the file drops to zero, because some process might still hold a reference to the inode in memory: a process might still

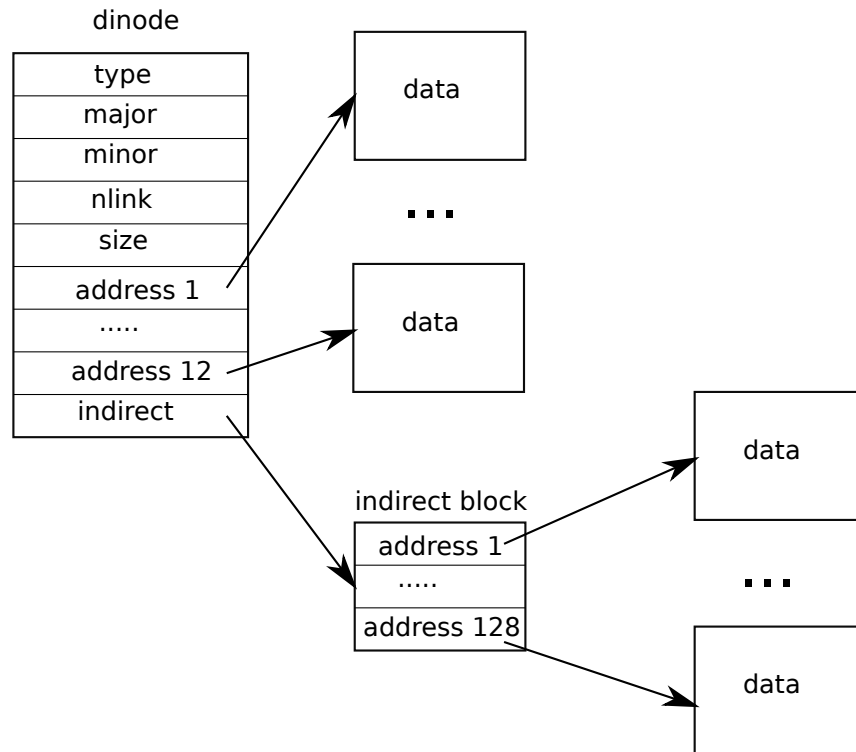

Figure 6-3. The representation of a file on disk.

be reading and writing to the file, because it successfully opened it. But, if a crash happens before the last process closes the file descriptor for the file, then the file will be marked allocated on disk but no directory entry points to it.

`struct dinode+code`
`NDIRECT+code`

File systems handle this case in one of two ways. The simple solution is that on recovery, after reboot, the file system scans the whole file system for files that are marked allocated, but have no directory entry pointing to them. If any such file exists, then it can free those files.

The second solution doesn't require scanning the file system. In this solution, the file system records on disk (e.g., in the super block) the inode number of a file whose link count drops to zero but whose reference count isn't zero. If the file system removes the file when its reference counts reaches 0, then it updates the on-disk list by removing that inode from the list. On recovery, the file system frees any file in the list.

Xv6 implements neither solution, which means that inodes may be marked allocated on disk, even though they are not in use anymore. This means that over time xv6 runs the risk that it may run out of disk space.

Code: Inode content

The on-disk inode structure, `struct dinode`, contains a `size` and an array of block numbers (see Figure 6-3). The inode data is found in the blocks listed in the `dinode`'s `addrs` array. The first `NDIRECT` blocks of data are listed in the first `NDIRECT`

entries in the array; these blocks are called `direct blocks`. The next `NINDIRECT` blocks of data are listed not in the inode but in a data block called the `indirect block`. The last entry in the `addrs` array gives the address of the indirect block. Thus the first 6 kB (`NDIRECT×BSIZE`) bytes of a file can be loaded from blocks listed in the inode, while the next 64kB (`NINDIRECT×BSIZE`) bytes can only be loaded after consulting the indirect block. This is a good on-disk representation but a complex one for clients. The function `bmap` manages the representation so that higher-level routines such as `readi` and `writei`, which we will see shortly. `Bmap` returns the disk block number of the `bn`'th data block for the inode `ip`. If `ip` does not have such a block yet, `bmap` allocates one.

The function `bmap` (5410) begins by picking off the easy case: the first `NDIRECT` blocks are listed in the inode itself (5415-5419). The next `NINDIRECT` blocks are listed in the indirect block at `ip->addrs[NDIRECT]`. `Bmap` reads the indirect block (5426) and then reads a block number from the right position within the block (5427). If the block number exceeds `NDIRECT+NINDIRECT`, `bmap` panics; `writei` contains the check that prevents this from happening (5566).

`Bmap` allocates blocks as needed. An `ip->addrs[]` or indirect entry of zero indicates that no block is allocated. As `bmap` encounters zeros, it replaces them with the numbers of fresh blocks, allocated on demand. (5416-5417, 5424-5425).

`itrunc` frees a file's blocks, resetting the inode's size to zero. `Itrunc` (5456) starts by freeing the direct blocks (5462-5467), then the ones listed in the indirect block (5472-5475), and finally the indirect block itself (5477-5478).

`Bmap` makes it easy for `readi` and `writei` to get at an inode's data. `Readi` (5503) starts by making sure that the offset and count are not beyond the end of the file. Reads that start beyond the end of the file return an error (5514-5515) while reads that start at or cross the end of the file return fewer bytes than requested (5516-5517). The main loop processes each block of the file, copying data from the buffer into `dst` (5519-5524). `writei` (5553) is identical to `readi`, with three exceptions: writes that start at or cross the end of the file grow the file, up to the maximum file size (5566-5567); the loop copies data into the buffers instead of out (5572); and if the write has extended the file, `writei` must update its size (5577-5580).

Both `readi` and `writei` begin by checking for `ip->type == T_DEV`. This case handles special devices whose data does not live in the file system; we will return to this case in the file descriptor layer.

The function `stati` (4974) copies inode metadata into the `stat` structure, which is exposed to user programs via the `stat` system call.

Code: directory layer

A directory is implemented internally much like a file. Its inode has type `T_DIR` and its data is a sequence of directory entries. Each entry is a `struct dirent` (4115), which contains a name and an inode number. The name is at most `DIRSIZ` (14) characters; if shorter, it is terminated by a `NUL` (0) byte. Directory entries with inode number zero are free.

The function `dirlookup` (5611) searches a directory for an entry with the given

direct blocks
`NINDIRECT+code`
indirect block
`BSIZE+code`
`bmap+code`
`readi+code`
`writei+code`
`bmap+code`
`NDIRECT+code`
`NINDIRECT+code`
`itrunc+code`
`readi+code`
`writei+code`
`writei+code`
`readi+code`
`writei+code`
`readi+code`
`writei+code`
`readi+code`
`T_DEV+code`
`stati+code`
`stat+code`
`T_DIR+code`
`struct dirent+code`
`DIRSIZ+code`
`dirlookup+code`

name. If it finds one, it returns a pointer to the corresponding inode, unlocked, and sets `*poff` to the byte offset of the entry within the directory, in case the caller wishes to edit it. If `dirlookup` finds an entry with the right name, it updates `*poff`, releases the block, and returns an unlocked inode obtained via `iget`. `Dirlookup` is the reason that `iget` returns unlocked inodes. The caller has locked `dp`, so if the lookup was for `.`, an alias for the current directory, attempting to lock the inode before returning would try to re-lock `dp` and deadlock. (There are more complicated deadlock scenarios involving multiple processes and `..`, an alias for the parent directory; `.` is not the only problem.) The caller can unlock `dp` and then lock `ip`, ensuring that it only holds one lock at a time.

`iget+code`
`..+code`
`..+code`
`dirlink+code`
`dirlookup+code`
`nameiparent+code`
`namex+code`
`skipelem+code`
`ilock+code`
`nameiparent+code`
`namex+code`
`dirlookup+code`

The function `dirlink` (5652) writes a new directory entry with the given name and inode number into the directory `dp`. If the name already exists, `dirlink` returns an error (5658-5662). The main loop reads directory entries looking for an unallocated entry. When it finds one, it stops the loop early (5622-5623), with `off` set to the offset of the available entry. Otherwise, the loop ends with `off` set to `dp->size`. Either way, `dirlink` then adds a new entry to the directory by writing at offset `off` (5672-5675).

Code: Path names

Path name lookup involves a succession of calls to `dirlookup`, one for each path component. `Namei` (5790) evaluates `path` and returns the corresponding inode. The function `nameiparent` is a variant: it stops before the last element, returning the inode of the parent directory and copying the final element into `name`. Both call the generalized function `namex` to do the real work.

`Namex` (5755) starts by deciding where the path evaluation begins. If the path begins with a slash, evaluation begins at the root; otherwise, the current directory (5759-5762). Then it uses `skipelem` to consider each element of the path in turn (5764). Each iteration of the loop must look up `name` in the current inode `ip`. The iteration begins by locking `ip` and checking that it is a directory. If not, the lookup fails (5765-5769). (Locking `ip` is necessary not because `ip->type` can change underfoot—it can’t—but because until `ilock` runs, `ip->type` is not guaranteed to have been loaded from disk.) If the call is `nameiparent` and this is the last path element, the loop stops early, as per the definition of `nameiparent`; the final path element has already been copied into `name`, so `namex` need only return the unlocked `ip` (5770-5774). Finally, the loop looks for the path element using `dirlookup` and prepares for the next iteration by setting `ip = next` (5775-5780). When the loop runs out of path elements, it returns `ip`.

The procedure `namex` may take a long time to complete: it could involve several disk operations to read inodes and directory blocks for the directories traversed in the pathname (if they are not in the buffer cache). `Xv6` is carefully designed so that if an invocation of `namex` by one kernel thread is blocked on a disk I/O, another kernel thread looking up a different pathname can proceed concurrently. `namex` locks each directory in the path separately so that lookups in different directories can proceed in parallel.

This concurrency introduces some challenges. For example, while one kernel thread is looking up a pathname another kernel thread may be changing the directory

tree by unlinking a directory. A potential risk is that a lookup may be searching a directory that has been deleted by another kernel thread and its blocks have been re-used for another directory or file.

Xv6 avoids such races. For example, when executing `dirlookup` in `namex`, the lookup thread holds the lock on the directory and `dirlookup` returns an inode that was obtained using `iget`. `iget` increases the reference count of the inode. Only after receiving the inode from `dirlookup` does `namex` release the lock on the directory. Now another thread may unlink the inode from the directory but `xv6` will not delete the inode yet, because the reference count of the inode is still larger than zero.

Another risk is deadlock. For example, `next` points to the same inode as `ip` when looking up `"."`. Locking `next` before releasing the lock on `ip` would result in a deadlock. To avoid this deadlock, `namex` unlocks the directory before obtaining a lock on `next`. Here again we see why the separation between `iget` and `ilock` is important.

```
struct file+code
open+code
dup+code
fork+code
ftable+code
filealloc+code
filedup+code
fileclose+code
fileread+code
filewrite+code
filedup+code
fileclose+code
filestat+code
fileread+code
filewrite+code
stat+code
read+code
write+code
stati+code
```

File descriptor layer

A cool aspect of the Unix interface is that most resources in Unix are represented as files, including devices such as the console, pipes, and of course, real files. The file descriptor layer is the layer that achieves this uniformity.

Xv6 gives each process its own table of open files, or file descriptors, as we saw in Chapter 0. Each open file is represented by a `struct file` (4150), which is a wrapper around either an inode or a pipe, plus an i/o offset. Each call to `open` creates a new open file (a new `struct file`): if multiple processes open the same file independently, the different instances will have different i/o offsets. On the other hand, a single open file (the same `struct file`) can appear multiple times in one process's file table and also in the file tables of multiple processes. This would happen if one process used `open` to open the file and then created aliases using `dup` or shared it with a child using `fork`. A reference count tracks the number of references to a particular open file. A file can be open for reading or writing or both. The `readable` and `writable` fields track this.

All the open files in the system are kept in a global file table, the `ftable`. The file table has a function to allocate a file (`filealloc`), create a duplicate reference (`filedup`), release a reference (`fileclose`), and read and write data (`fileread` and `filewrite`).

The first three follow the now-familiar form. `filealloc` (5876) scans the file table for an unreferenced file (`f->ref == 0`) and returns a new reference; `filedup` (5902) increments the reference count; and `fileclose` (5914) decrements it. When a file's reference count reaches zero, `fileclose` releases the underlying pipe or inode, according to the type.

The functions `filestat`, `fileread`, and `filewrite` implement the `stat`, `read`, and `write` operations on files. `filestat` (5952) is only allowed on inodes and calls `stati`. `fileread` and `filewrite` check that the operation is allowed by the open mode and then pass the call through to either the pipe or inode implementation. If the file represents an inode, `fileread` and `filewrite` use the i/o offset as the offset for the operation and then advance it (5975-5976, 6015-6016). Pipes have no concept of off-

set. Recall that the inode functions require the caller to handle locking (5955-5957, 5974-5977, 6014-6028). The inode locking has the convenient side effect that the read and write offsets are updated atomically, so that multiple writing to the same file simultaneously cannot overwrite each other's data, though their writes may end up interlaced.

Code: System calls

With the functions that the lower layers provide the implementation of most system calls is trivial (see `sysfile.c`). There are a few calls that deserve a closer look.

The functions `sys_link` and `sys_unlink` edit directories, creating or removing references to inodes. They are another good example of the power of using transactions. `sys_link` (6202) begins by fetching its arguments, two strings `old` and `new` (6207). Assuming `old` exists and is not a directory (6211-6214), `sys_link` increments its `ip->nlink` count. Then `sys_link` calls `nameiparent` to find the parent directory and final path element of `new` (6227) and creates a new directory entry pointing at `old`'s inode (6230). The new parent directory must exist and be on the same device as the existing inode: inode numbers only have a unique meaning on a single disk. If an error like this occurs, `sys_link` must go back and decrement `ip->nlink`.

Transactions simplify the implementation because it requires updating multiple disk blocks, but we don't have to worry about the order in which we do them. They either will all succeed or none. For example, without transactions, updating `ip->nlink` before creating a link, would put the file system temporarily in an unsafe state, and a crash in between could result in havoc. With transactions we don't have to worry about this.

`sys_link` creates a new name for an existing inode. The function `create` (6357) creates a new name for a new inode. It is a generalization of the three file creation system calls: `open` with the `O_CREATE` flag makes a new ordinary file, `mkdir` makes a new directory, and `mkdev` makes a new device file. Like `sys_link`, `create` starts by calling `nameiparent` to get the inode of the parent directory. It then calls `dirlookup` to check whether the name already exists (6367). If the name does exist, `create`'s behavior depends on which system call it is being used for: `open` has different semantics from `mkdir` and `mkdev`. If `create` is being used on behalf of `open` (`type == T_FILE`) and the name that exists is itself a regular file, then `open` treats that as a success, so `create` does too (6371). Otherwise, it is an error (6372-6373). If the name does not already exist, `create` now allocates a new inode with `ialloc` (6376). If the new inode is a directory, `create` initializes it with `.` and `..` entries. Finally, now that the data is initialized properly, `create` can link it into the parent directory (6389). `create`, like `sys_link`, holds two inode locks simultaneously: `ip` and `dp`. There is no possibility of deadlock because the inode `ip` is freshly allocated: no other process in the system will hold `ip`'s lock and then try to lock `dp`.

Using `create`, it is easy to implement `sys_open`, `sys_mkdir`, and `sys_mknod`. `sys_open` (6401) is the most complex, because creating a new file is only a small part of what it can do. If `open` is passed the `O_CREATE` flag, it calls `create` (6414). Otherwise, it calls `namei` (6420). `create` returns a locked inode, but `namei` does not, so `sys_open` must lock the inode itself. This provides a convenient place to check that directories

```

sys_link+code
sys_unlink+code
nameiparent+code
sys_link+code
create+code
open+code
O_CREATE+code
mkdir+code
mkdev+code
sys_link+code
create+code
nameiparent+code
dirlookup+code
mkdir+code
mkdev+code
T_FILE+code
ialloc+code
.+code
..+code
create+code
sys_link+code
sys_open+code
sys_mkdir+code
sys_mknod+code
open+code
O_CREATE+code
namei+code
sys_open+code

```

are only opened for reading, not writing. Assuming the inode was obtained one way or the other, `sys_open` allocates a file and a file descriptor (6432) and then fills in the file (6442-6446). Note that no other process can access the partially initialized file since it is only in the current process's table.

`sys_pipe+code`
`fsck+code`

Chapter 5 examined the implementation of pipes before we even had a file system. The function `sys_pipe` connects that implementation to the file system by providing a way to create a pipe pair. Its argument is a pointer to space for two integers, where it will record the two new file descriptors. Then it allocates the pipe and installs the file descriptors.

Real world

The buffer cache in a real-world operating system is significantly more complex than xv6's, but it serves the same two purposes: caching and synchronizing access to the disk. Xv6's buffer cache, like V6's, uses a simple least recently used (LRU) eviction policy; there are many more complex policies that can be implemented, each good for some workloads and not as good for others. A more efficient LRU cache would eliminate the linked list, instead using a hash table for lookups and a heap for LRU evictions. Modern buffer caches are typically integrated with the virtual memory system to support memory-mapped files.

Xv6's logging system is inefficient. A commit cannot occur concurrently with file system system calls. The system logs entire blocks, even if only a few bytes in a block are changed. It performs synchronous log writes, a block at a time, each of which is likely to require an entire disk rotation time. Real logging systems address all of these problems.

Logging is not the only way to provide crash recovery. Early file systems used a scavenger during reboot (for example, the UNIX `fsck` program) to examine every file and directory and the block and inode free lists, looking for and resolving inconsistencies. Scavenging can take hours for large file systems, and there are situations where it is not possible to resolve inconsistencies in a way that causes the original system calls to be atomic. Recovery from a log is much faster and causes system calls to be atomic in the face of crashes.

Xv6 uses the same basic on-disk layout of inodes and directories as early UNIX; this scheme has been remarkably persistent over the years. BSD's UFS/FFS and Linux's `ext2/ext3` use essentially the same data structures. The most inefficient part of the file system layout is the directory, which requires a linear scan over all the disk blocks during each lookup. This is reasonable when directories are only a few disk blocks, but is expensive for directories holding many files. Microsoft Windows's NTFS, Mac OS X's HFS, and Solaris's ZFS, just to name a few, implement a directory as an on-disk balanced tree of blocks. This is complicated but guarantees logarithmic-time directory lookups.

Xv6 is naive about disk failures: if a disk operation fails, xv6 panics. Whether this is reasonable depends on the hardware: if an operating system sits atop special hardware that uses redundancy to mask disk failures, perhaps the operating system sees failures so infrequently that panicking is okay. On the other hand, operating systems

using plain disks should expect failures and handle them more gracefully, so that the loss of a block in one file doesn't affect the use of the rest of the file system.

Xv6 requires that the file system fit on one disk device and not change in size. As large databases and multimedia files drive storage requirements ever higher, operating systems are developing ways to eliminate the "one disk per file system" bottleneck. The basic approach is to combine many disks into a single logical disk. Hardware solutions such as RAID are still the most popular, but the current trend is moving toward implementing as much of this logic in software as possible. These software implementations typically allow rich functionality like growing or shrinking the logical device by adding or removing disks on the fly. Of course, a storage layer that can grow or shrink on the fly requires a file system that can do the same: the fixed-size array of inode blocks used by xv6 would not work well in such environments. Separating disk management from the file system may be the cleanest design, but the complex interface between the two has led some systems, like Sun's ZFS, to combine them.

Xv6's file system lacks many other features of modern file systems; for example, it lacks support for snapshots and incremental backup.

Modern Unix systems allow many kinds of resources to be accessed with the same system calls as on-disk storage: named pipes, network connections, remotely-accessed network file systems, and monitoring and control interfaces such as `/proc`. Instead of xv6's `if` statements in `fileread` and `filewrite`, these systems typically give each open file a table of function pointers, one per operation, and call the function pointer to invoke that inode's implementation of the call. Network file systems and user-level file systems provide functions that turn those calls into network RPCs and wait for the response before returning.

Exercises

1. Why panic in `ballocc`? Can xv6 recover?
2. Why panic in `iallocc`? Can xv6 recover?
3. Why doesn't `fileallocc` panic when it runs out of files? Why is this more common and therefore worth handling?
4. Suppose the file corresponding to `ip` gets unlinked by another process between `sys_link`'s calls to `iunlock(ip)` and `dirlink`. Will the link be created correctly? Why or why not?
6. `create` makes four function calls (one to `iallocc` and three to `dirlink`) that it requires to succeed. If any doesn't, `create` calls `panic`. Why is this acceptable? Why can't any of those four calls fail?
7. `sys_chdir` calls `iunlock(ip)` before `iput(cp->cwd)`, which might try to lock `cp->cwd`, yet postponing `iunlock(ip)` until after the `iput` would not cause deadlocks. Why not?
8. Implement the `lseek` system call. Supporting `lseek` will also require that you modify `filewrite` to fill holes in the file with zero if `lseek` sets off beyond `f->ip->size`.
9. Add `O_TRUNC` and `O_APPEND` to `open`, so that `>` and `>>` operators work in the shell.

Chapter 7

Summary

This text introduced the main ideas in operating systems by studying one operating system, xv6, line by line. Some code lines embody the essence of the main ideas (e.g., context switching, user/kernel boundary, locks, etc.) and each line is important; other code lines provide an illustration of how to implement a particular operating system idea and could easily be done in different ways (e.g., a better algorithm for scheduling, better on-disk data structures to represent files, better logging to allow for concurrent transactions, etc.). All the ideas were illustrated in the context of one particular, very successful system call interface, the Unix interface, but those ideas carry over to the design of other operating systems.

Appendix A

PC hardware

This appendix describes personal computer (PC) hardware, the platform on which xv6 runs.

A PC is a computer that adheres to several industry standards, with the goal that a given piece of software can run on PCs sold by multiple vendors. These standards evolve over time and a PC from 1990s doesn't look like a PC now. Many of the current standards are public and you can find documentation for them online.

From the outside a PC is a box with a keyboard, a screen, and various devices (e.g., CD-ROM, etc.). Inside the box is a circuit board (the “motherboard”) with CPU chips, memory chips, graphic chips, I/O controller chips, and busses through which the chips communicate. The busses adhere to standard protocols (e.g., PCI and USB) so that devices will work with PCs from multiple vendors.

From our point of view, we can abstract the PC into three components: CPU, memory, and input/output (I/O) devices. The CPU performs computation, the memory contains instructions and data for that computation, and devices allow the CPU to interact with hardware for storage, communication, and other functions.

You can think of main memory as connected to the CPU with a set of wires, or lines, some for address bits, some for data bits, and some for control flags. To read a value from main memory, the CPU sends high or low voltages representing 1 or 0 bits on the address lines and a 1 on the “read” line for a prescribed amount of time and then reads back the value by interpreting the voltages on the data lines. To write a value to main memory, the CPU sends appropriate bits on the address and data lines and a 1 on the “write” line for a prescribed amount of time. Real memory interfaces are more complex than this, but the details are only important if you need to achieve high performance.

Processor and memory

A computer's CPU (central processing unit, or processor) runs a conceptually simple loop: it consults an address in a register called the `program counter`, reads a machine instruction from that address in memory, advances the program counter past the instruction, and executes the instruction. Repeat. If the execution of the instruction does not modify the program counter, this loop will interpret the memory pointed at by the program counter as a sequence of machine instructions to run one after the other. Instructions that do change the program counter include branches and function calls.

The execution engine is useless without the ability to store and modify program data. The fastest storage for data is provided by the processor's register set. A register is a storage cell inside the processor itself, capable of holding a machine word-sized

value (typically 16, 32, or 64 bits). Data stored in registers can typically be read or written quickly, in a single CPU cycle.

PCs have a processor that implements the x86 instruction set, which was originally defined by Intel and has become a standard. Several manufacturers produce processors that implement the instruction set. Like all other PC standards, this standard is also evolving but newer standards are backwards compatible with past standards. The boot loader has to deal with some of this evolution because every PC processor starts simulating an Intel 8088, the CPU chip in the original IBM PC released in 1981. However, for most of xv6 you will be concerned with the modern x86 instruction set.

The modern x86 provides eight general purpose 32-bit registers—`%eax`, `%ebx`, `%ecx`, `%edx`, `%edi`, `%esi`, `%ebp`, and `%esp`—and a program counter `%eip` (the instruction pointer). The common `e` prefix stands for extended, as these are 32-bit extensions of the 16-bit registers `%ax`, `%bx`, `%cx`, `%dx`, `%di`, `%si`, `%bp`, `%sp`, and `%ip`. The two register sets are aliased so that, for example, `%ax` is the bottom half of `%eax`: writing to `%ax` changes the value stored in `%eax` and vice versa. The first four registers also have names for the bottom two 8-bit bytes: `%al` and `%ah` denote the low and high 8 bits of `%ax`; `%bl`, `%bh`, `%cl`, `%ch`, `%dl`, and `%dh` continue the pattern. In addition to these registers, the x86 has eight 80-bit floating-point registers as well as a handful of special-purpose registers like the control registers `%cr0`, `%cr2`, `%cr3`, and `%cr4`; the debug registers `%dr0`, `%dr1`, `%dr2`, and `%dr3`; the segment registers `%cs`, `%ds`, `%es`, `%fs`, `%gs`, and `%ss`; and the global and local descriptor table pseudo-registers `%gdtr` and `%ldtr`. The control registers and segment registers are important to any operating system. The floating-point and debug registers are less interesting and not used by xv6.

Registers are fast but expensive. Most processors provide at most a few tens of general-purpose registers. The next conceptual level of storage is the main random-access memory (RAM). Main memory is 10-100x slower than a register, but it is much cheaper, so there can be more of it. One reason main memory is relatively slow is that it is physically separate from the processor chip. An x86 processor has a few dozen registers, but a typical PC today has gigabytes of main memory. Because of the enormous differences in both access speed and size between registers and main memory, most processors, including the x86, store copies of recently-accessed sections of main memory in on-chip cache memory. The cache memory serves as a middle ground between registers and memory both in access time and in size. Today's x86 processors typically have three levels of cache. Each core has a small first-level cache with access times relatively close to the processor's clock rate and a larger second-level cache. Several cores share an L3 cache. Figure A-1 shows the levels in the memory hierarchy and their access times for an Intel i7 Xeon processor.

For the most part, x86 processors hide the cache from the operating system, so we can think of the processor as having just two kinds of storage—registers and memory—and not worry about the distinctions between the different levels of the memory hierarchy.

I/O

Processors must communicate with devices as well as memory. The x86 processor

Intel Core i7 Xeon 5500 at 2.4 GHz		
Memory	Access time	Size
register	1 cycle	64 bytes
L1 cache	~4 cycles	64 kilobytes
L2 cache	~10 cycles	4 megabytes
L3 cache	~40-75 cycles	8 megabytes
remote L3	~100-300 cycles	
Local DRAM	~60 nsec	
Remote DRAM	~100 nsec	

Figure A-1. Latency numbers for an Intel i7 Xeon system, based on http://software.intel.com/sites/products/collateral/hpc/vtune/performance_analysis_guide.pdf.

provides special in and out instructions that read and write values from device addresses called I/O ports. The hardware implementation of these instructions is essentially the same as reading and writing memory. Early x86 processors had an extra address line: 0 meant read/write from an I/O port and 1 meant read/write from main memory. Each hardware device monitors these lines for reads and writes to its assigned range of I/O ports. A device's ports let the software configure the device, examine its status, and cause the device to take actions; for example, software can use I/O port reads and writes to cause the disk interface hardware to read and write sectors on the disk.

I/O ports
memory-mapped
I/O

Many computer architectures have no separate device access instructions. Instead the devices have fixed memory addresses and the processor communicates with the device (at the operating system's behest) by reading and writing values at those addresses. In fact, modern x86 architectures use this technique, called memory-mapped I/O, for most high-speed devices such as network, disk, and graphics controllers. For reasons of backwards compatibility, though, the old in and out instructions linger, as do legacy hardware devices that use them, such as the IDE disk controller, which xv6 uses.

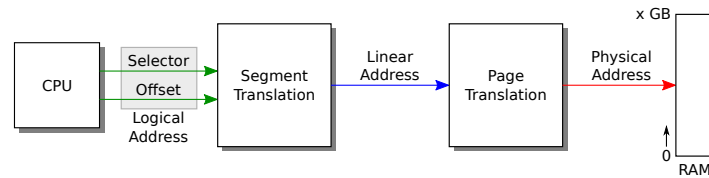

logical address
linear address
physical address

Figure B-1. The relationship between logical, linear, and physical addresses.

Appendix B

boot loader
boot loader
real mode

The boot loader

When an x86 PC boots, it starts executing a program called the BIOS (Basic Input/Output System), which is stored in non-volatile memory on the motherboard. The BIOS’s job is to prepare the hardware and then transfer control to the operating system. Specifically, it transfers control to code loaded from the boot sector, the first 512-byte sector of the boot disk. The boot sector contains the boot loader: instructions that load the kernel into memory. The BIOS loads the boot sector at memory address 0x7c00 and then jumps (sets the processor’s %ip) to that address. When the boot loader begins executing, the processor is simulating an Intel 8088, and the loader’s job is to put the processor in a more modern operating mode, to load the xv6 kernel from disk into memory, and then to transfer control to the kernel. The xv6 boot loader comprises two source files, one written in a combination of 16-bit and 32-bit x86 assembly (`bootasm.S`; (9100)) and one written in C (`bootmain.c`; (9200)).

Code: Assembly bootstrap

The first instruction in the boot loader is `ccli` (9112), which disables processor interrupts. Interrupts are a way for hardware devices to invoke operating system functions called interrupt handlers. The BIOS is a tiny operating system, and it might have set up its own interrupt handlers as part of the initializing the hardware. But the BIOS isn’t running anymore—the boot loader is—so it is no longer appropriate or safe to handle interrupts from hardware devices. When xv6 is ready (in Chapter 3), it will re-enable interrupts.

The processor is in `real mode`, in which it simulates an Intel 8088. In real mode there are eight 16-bit general-purpose registers, but the processor sends 20 bits of address to memory. The segment registers `%cs`, `%ds`, `%es`, and `%ss` provide the additional bits necessary to generate 20-bit memory addresses from 16-bit registers. When a program refers to a memory address, the processor automatically adds 16 times the value of one of the segment registers; these registers are 16 bits wide. Which segment register is usually implicit in the kind of memory reference: instruction fetches use `%cs`, data reads and writes use `%ds`, and stack reads and writes use `%ss`.

Xv6 pretends that an x86 instruction uses a virtual address for its memory operands, but an x86 instruction actually uses a `logical` address (see Figure B-1). A logical address consists of a segment selector and an offset, and is sometimes written as *segment:offset*. More often, the segment is implicit and the program only directly manipulates the offset. The segmentation hardware performs the translation described above to generate a `linear` address. If the paging hardware is enabled (see Chapter 2), it translates linear addresses to physical addresses; otherwise the processor uses linear addresses as physical addresses.

boot loader
logical address
linear address
virtual address
protected mode
segment descriptor
table
gdt+code

The boot loader does not enable the paging hardware; the logical addresses that it uses are translated to linear addresses by the segmentation hardware, and then used directly as physical addresses. Xv6 configures the segmentation hardware to translate logical to linear addresses without change, so that they are always equal. For historical reasons we have used the term `virtual` address to refer to addresses manipulated by programs; an xv6 virtual address is the same as an x86 logical address, and is equal to the linear address to which the segmentation hardware maps it. Once paging is enabled, the only interesting address mapping in the system will be linear to physical.

The BIOS does not guarantee anything about the contents of `%ds`, `%es`, `%ss`, so first order of business after disabling interrupts is to set `%ax` to zero and then copy that zero into `%ds`, `%es`, and `%ss` (9115-9118).

A virtual *segment:offset* can yield a 21-bit physical address, but the Intel 8088 could only address 20 bits of memory, so it discarded the top bit: $0xffff0+0xffff = 0x10ffef$, but virtual address `0xffff:0xffff` on the 8088 referred to physical address `0x0ffef`. Some early software relied on the hardware ignoring the 21st address bit, so when Intel introduced processors with more than 20 bits of physical address, IBM provided a compatibility hack that is a requirement for PC-compatible hardware. If the second bit of the keyboard controller's output port is low, the 21st physical address bit is always cleared; if high, the 21st bit acts normally. The boot loader must enable the 21st address bit using I/O to the keyboard controller on ports `0x64` and `0x60` (9120-9136).

Real mode's 16-bit general-purpose and segment registers make it awkward for a program to use more than 65,536 bytes of memory, and impossible to use more than a megabyte. x86 processors since the 80286 have a `protected mode`, which allows physical addresses to have many more bits, and (since the 80386) a "32-bit" mode that causes registers, virtual addresses, and most integer arithmetic to be carried out with 32 bits rather than 16. The xv6 boot sequence enables `protected mode` and `32-bit mode` as follows.

In `protected mode`, a segment register is an index into a `segment descriptor table` (see Figure B-2). Each table entry specifies a base physical address, a maximum virtual address called the `limit`, and permission bits for the segment. These permissions are the protection in `protected mode`: the kernel can use them to ensure that a program uses only its own memory.

xv6 makes almost no use of segments; it uses the paging hardware instead, as Chapter 2 describes. The boot loader sets up the `segment descriptor table` `gdt` (9182-9185) so that all segments have a base address of zero and the maximum possible limit (four gigabytes). The table has a null entry, one entry for executable code, and one en-

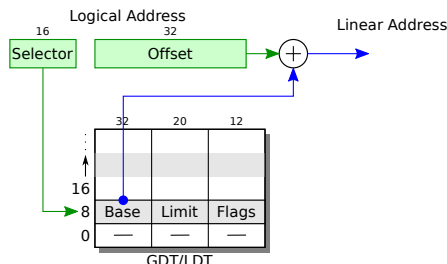

Figure B-2. Segments in protected mode.

try to data. The code segment descriptor has a flag set that indicates that the code should run in 32-bit mode (0660). With this setup, when the boot loader enters protected mode, logical addresses map one-to-one to physical addresses.

The boot loader executes an `lgdt` instruction (9141) to load the processor's global descriptor table (GDT) register with the value `gdt_desc` (9187-9189), which points to the table `gdt`.

Once it has loaded the GDT register, the boot loader enables protected mode by setting the 1 bit (`CR0_PE`) in register `%cr0` (9142-9144). Enabling protected mode does not immediately change how the processor translates logical to physical addresses; it is only when one loads a new value into a segment register that the processor reads the GDT and changes its internal segmentation settings. One cannot directly modify `%cs`, so instead the code executes an `ljmp` (far jump) instruction (9153), which allows a code segment selector to be specified. The jump continues execution at the next line (9156) but in doing so sets `%cs` to refer to the code descriptor entry in `gdt`. That descriptor describes a 32-bit code segment, so the processor switches into 32-bit mode. The boot loader has nursed the processor through an evolution from 8088 through 80286 to 80386.

The boot loader's first action in 32-bit mode is to initialize the data segment registers with `SEG_KDATA` (9158-9161). Logical address now map directly to physical addresses. The only step left before executing C code is to set up a stack in an unused region of memory. The memory from `0xa0000` to `0x100000` is typically littered with device memory regions, and the `xv6` kernel expects to be placed at `0x100000`. The boot loader itself is at `0x7c00` through `0x7e00` (512 bytes). Essentially any other section of memory would be a fine location for the stack. The boot loader chooses `0x7c00` (known in this file as `$start`) as the top of the stack; the stack will grow down from there, toward `0x0000`, away from the boot loader.

Finally the boot loader calls the C function `bootmain` (9168). `bootmain`'s job is to load and run the kernel. It only returns if something has gone wrong. In that case, the code sends a few output words on port `0x8a00` (9170-9176). On real hardware, there is no device connected to that port, so this code does nothing. If the boot loader is running inside a PC simulator, port `0x8a00` is connected to the simulator itself and can transfer control back to the simulator. Simulator or not, the code then executes an infinite loop (9177-9178). A real boot loader might attempt to print an error message first.

boot loader
global descriptor
table
`gdt_desc+code`
`gdt+code`
`CR0_PE+code`
`gdt+code`
`SEG_KDATA+code`
`bootmain+code`

Code: C bootstrap

readseg+code
stosb+code
_start+code
entry+code

The C part of the boot loader, `bootmain.c` (9200), expects to find a copy of the kernel executable on the disk starting at the second sector. The kernel is an ELF format binary, as we have seen in Chapter 2. To get access to the ELF headers, `bootmain` loads the first 4096 bytes of the ELF binary (9214). It places the in-memory copy at address `0x10000`.

The next step is a quick check that this probably is an ELF binary, and not an uninitialized disk. `Bootmain` reads the section's content starting from the disk location `off` bytes after the start of the ELF header, and writes to memory starting at address `paddr`. `Bootmain` calls `readseg` to load data from disk (9238) and calls `stosb` to zero the remainder of the segment (9240). `Stosb` (0492) uses the x86 instruction `rep stosb` to initialize every byte of a block of memory.

The kernel has been compiled and linked so that it expects to find itself at virtual addresses starting at `0x80100000`. Thus, function call instructions must mention destination addresses that look like `0x801xxxxx`; you can see examples in `kernel.asm`. This address is configured in `kernel.ld`. `0x80100000` is a relatively high address, towards the end of the 32-bit address space; Chapter 2 explains the reasons for this choice. There may not be any physical memory at such a high address. Once the kernel starts executing, it will set up the paging hardware to map virtual addresses starting at `0x80100000` to physical addresses starting at `0x00100000`; the kernel assumes that there is physical memory at this lower address. At this point in the boot process, however, paging is not enabled. Instead, `kernel.ld` specifies that the ELF `paddr` start at `0x00100000`, which causes the boot loader to copy the kernel to the low physical addresses to which the paging hardware will eventually point.

The boot loader's final step is to call the kernel's entry point, which is the instruction at which the kernel expects to start executing. For `xv6` the entry address is `0x10000c`:

```
# objdump -f kernel

kernel:      file format elf32-i386
architecture: i386, flags 0x00000112:
EXEC_P, HAS_SYMS, D_PAGED
start address 0x0010000c
```

By convention, the `_start` symbol specifies the ELF entry point, which is defined in the file `entry.S` (1040). Since `xv6` hasn't set up virtual memory yet, `xv6's` entry point is the physical address of entry (1044).

Real world

The boot loader described in this appendix compiles to around 470 bytes of machine code, depending on the optimizations used when compiling the C code. In order to fit in that small amount of space, the `xv6` boot loader makes a major simplifying assumption, that the kernel has been written to the boot disk contiguously starting at sector 1. More commonly, kernels are stored in ordinary file systems, where they may not be contiguous, or are loaded over a network. These complications require the

boot loader to be able to drive a variety of disk and network controllers and understand various file systems and network protocols. In other words, the boot loader itself must be a small operating system. Since such complicated boot loaders certainly won't fit in 512 bytes, most PC operating systems use a two-step boot process. First, a simple boot loader like the one in this appendix loads a full-featured boot-loader from a known disk location, often relying on the less space-constrained BIOS for disk access rather than trying to drive the disk itself. Then the full loader, relieved of the 512-byte limit, can implement the complexity needed to locate, load, and execute the desired kernel. Modern PCs avoid many of the above complexities, because they support the Unified Extensible Firmware Interface (UEFI), which allows the PC to read a larger boot loader from the disk (and start it in protected and 32-bit mode).

This appendix is written as if the only thing that happens between power on and the execution of the boot loader is that the BIOS loads the boot sector. In fact the BIOS does a huge amount of initialization in order to make the complex hardware of a modern computer look like a traditional standard PC. The BIOS is really a small operating system embedded in the hardware, which is present after the computer has booted.

Exercises

1. Due to sector granularity, the call to `readseg` in the text is equivalent to `readseg((uchar*)0x100000, 0xb500, 0x1000)`. In practice, this sloppy behavior turns out not to be a problem. Why doesn't the sloppy `readsect` cause problems?
2. Suppose you wanted `bootmain()` to load the kernel at `0x200000` instead of `0x100000`, and you did so by modifying `bootmain()` to add `0x100000` to the `va` of each ELF section. Something would go wrong. What?
3. It seems potentially dangerous for the boot loader to copy the ELF header to memory at the arbitrary location `0x10000`. Why doesn't it call `malloc` to obtain the memory it needs?

Index

- ., 88, 90
- .., 88, 90
- /init, 27, 35
- _binary_initcode_size, 25
- _binary_initcode_start, 25
- _start, 102
- absorption, 82
- acquire, 54, 57
- addl, 26
- address space, 20
- allocproc, 23
- allocvm, 26, 35–36
- alltraps, 42–43
- argc, 36
- argfd, 45
- argint, 45
- argptr, 45
- argstr, 45
- argv, 36
- atomic, 54
- B_DIRTY, 47–48, 79–80
- B_VALID, 47–48, 79
- ballocc, 83, 85
- batch, 48
- batching, 81
- bcache.head, 79
- begin_op, 82
- bfree, 83
- bget, 79
- binit, 79
- block, 47
- bmap, 87
- boot loader, 22, 99–101
- bootmain, 101
- bread, 78, 80
- brelse, 78, 80
- BSIZE, 87
- buf, 78
- busy waiting, 48, 66
- bwrite, 78, 80, 82
- chan, 66, 69
- child process, 8
- cli, 46
- commit, 80
- conditional synchronization, 65
- contexts, 62
- control registers, 96
- convoys, 72
- copyout, 36
- coroutines, 64
- cp->tf, 44
- cpu->scheduler, 26, 62–63
- CRO_PE, 101
- CRO_PG, 23
- CR_PSE, 37
- crash recovery, 77
- create, 90
- critical section, 53
- current directory, 14
- deadlocked, 67
- direct blocks, 87
- dirlink, 88
- dirlookup, 87–88, 90
- DIRSIZ, 87
- DPL_USER, 25, 42
- driver, 46
- dup, 89
- ELF format, 35
- ELF_MAGIC, 35
- EMBRYO, 24
- end_op, 82
- entry, 22, 102
- entrypgdir, 22
- exception, 39
- exec, 9–11, 26, 36, 42
- exit, 8, 27, 63, 65, 71
- fetchint, 45
- file descriptor, 10
- filealloc, 89
- fileclose, 89
- filedup, 89
- fileread, 89, 92
- filestat, 89
- filewrite, 82, 89, 92
- FL_IF, 25
- fork, 8, 10–11, 89
- forkret, 24, 26, 64
- freerange, 33
- fsck, 91
- ftable, 89
- gdt, 100–101
- gdtdesc, 101
- getcmd, 10
- global descriptor table, 101
- group commit, 81
- I/O ports, 97
- ialloc, 85, 90
- IDE_BSY, 47
- IDE_DRDY, 47
- IDE_IRQ, 47
- ideinit, 47
- ideintr, 48, 56
- idelock, 55–56
- iderw, 47–48, 54, 56, 79–80
- idestart, 48
- idewait, 47
- idt, 42
- idtinit, 46
- IF, 42, 46
- iget, 84–85, 88
- ilock, 84–85, 88
- indirect block, 87
- initcode, 27
- initcode.S, 25–26, 41
- initlog, 82
- initproc, 26
- initvm, 25
- inode, 15, 77, 83
- insl, 48
- install_trans, 82
- instruction pointer, 96
- int, 40–42
- interface design, 7
- interrupt, 39
- interrupt handler, 40
- ioapicenable, 47
- iput, 84–85
- iret, 26, 41, 44
- IRQ_TIMER,, 46
- isolation, 17
- itrunc, 85, 87
- iunlock, 85
- kalloc, 33
- KERNBASE, 22
- kernel, 7, 19
- kernel mode, 18, 40
- kernel space, 7, 19
- kfree, 33

- kinit1, 33
- kinit2, 33
- kmap, 32
- kvmalloc, 30, 32
- lapicid, 65
- lapicinit, 46
- linear address, 99–100
- links, 15
- loadvm, 35
- lock, 51
- log, 80
- log_write, 82
- logical address, 99–100
- main, 23, 26, 32–33, 42, 47, 79
- malloc, 10
- mappages, 32
- memory-mapped I/O, 97
- mfks, 78
- microkernel, 19–20
- mkdev, 90
- mkdir, 90
- monolithic kernel, 17, 19
- mpmain, 25
- multiplexing, 61
- mutual exclusion, 53
- mycpu, 65
- myproc, 65
- namei, 25, 35, 90
- nameiparent, 88, 90
- namex, 88
- NBUF, 79
- NDIRECT, 86–87
- NINDIRECT, 87
- O_CREATE, 90
- open, 89–90
- p->context, 24, 26, 64
- p->cwd, 25
- p->kstack, 21, 72
- p->name, 25
- p->pgdir, 22, 72
- p->state, 22
- p->sz, 45
- p->xxx, 21
- page, 29
- page directory, 29
- page table entries (PTEs), 29
- page table pages, 29
- panic, 44
- parent process, 8
- path, 14
- persistence, 77
- PGROUNDUP, 33
- physical address, 20, 99
- PHYSTOP, 32–33
- pid, 8, 24
- pipe, 13
- piperead, 70
- pipewrite, 70
- polling, 48, 66
- popal, 26
- popcli, 57
- popl, 26
- printf, 9
- priority inversion, 72
- privileged instructions, 18
- proc->killed, 44
- process, 7–8, 20
- program counter, 95
- protected mode, 100–101
- ptable, 56
- ptable.lock, 63–64, 69
- PTE_P, 29
- PTE_U, 26, 30, 32
- PTE_W, 30
- pushcli, 57
- race condition, 52
- read, 89
- readi, 35, 87
- readseg, 102
- real mode, 99
- recover_from_log, 82
- recursive locks, 58
- release, 54, 57
- ret, 26
- root, 14
- round robin, 72
- RUNNABLE, 25, 64, 69, 71
- sbrk, 10, 34
- sched, 62–64, 69, 71
- scheduler, 25–26, 63–64
- sector, 47
- SEG_KDATA, 101
- SEG_TSS, 25
- SEG_UCODE, 25
- SEG_UDATA, 25
- seginit, 37
- segment descriptor table, 100
- segment registers, 96
- sequence coordination, 65
- serializing, 53
- setupkvm, 25, 32, 35
- shell, 8
- signal, 73
- skipelem, 88
- sleep, 63, 66, 68–69
- sleep-locks, 58
- SLEEPING, 69
- stat, 87, 89
- stati, 87, 89
- sti, 46
- stosb, 102
- struct buf, 47
- struct context, 62
- struct cpu, 65
- struct dinode, 83, 86
- struct dirent, 87
- struct elfhdr, 35
- struct file, 89
- struct inode, 84
- struct pipe, 70
- struct proc, 21, 71
- struct run, 33
- struct spinlock, 53
- struct trapframe, 25
- superblock, 78
- switchvm, 25, 42, 46, 64
- swtch, 26, 62–64, 72
- SYS_exec, 26, 44
- sys_exec, 42
- sys_link, 90
- sys_mkdir, 90
- sys_mknod, 90
- sys_open, 90
- sys_pipe, 91
- sys_sleep, 56
- sys_unlink, 90
- syscall, 44
- system call, 7
- T_DEV, 87
- T_DIR, 87
- T_FILE, 90
- T_SYSCALL, 26, 42, 44
- tf->trapno, 44
- thread, 21
- thundering herd, 73
- ticks, 56
- tickslock, 56
- time-share, 8, 17
- transaction, 77
- Translation Look-aside Buffer

(TLB), 35, 59
trap, 43–44, 46, 48, 62
trapret, 24, 26, 44
traps, 40
tvinit, 42
type cast, 33
unlink, 81
user memory, 20
user mode, 18, 40
user space, 7, 19
userinit, 25–26
ustack, 36
V2P_WO, 23
vectors[i], 42
virtual address, 20, 100
wait channel, 66
wait, 9, 65, 71
wakeup, 46, 56, 66, 69
wakeup1, 69
walkpgdir, 32, 35
write, 81, 89
writei, 83, 87
xchg, 54, 57
yield, 62–64
ZOMBIE, 71

